

# x530 Series

Stackable Gigabit Layer 3 Ethernet Switches  
AlliedWare Plus™ v5.5.2-2

- x530-10GHXm
- x530-18GHXm
- x530-28GTXm
- x530-28GPXm
- x530-28GSX
- x530-52GTXm
- x530-52GPXm

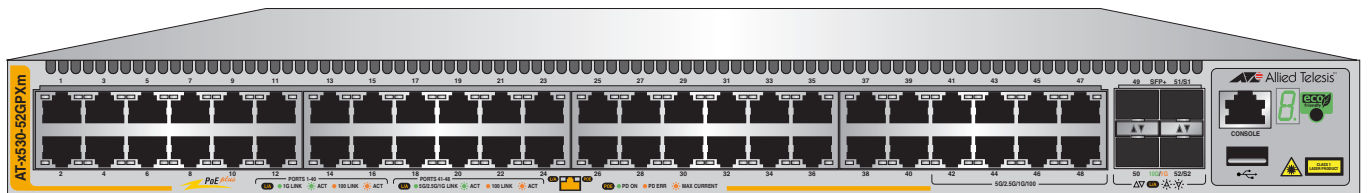
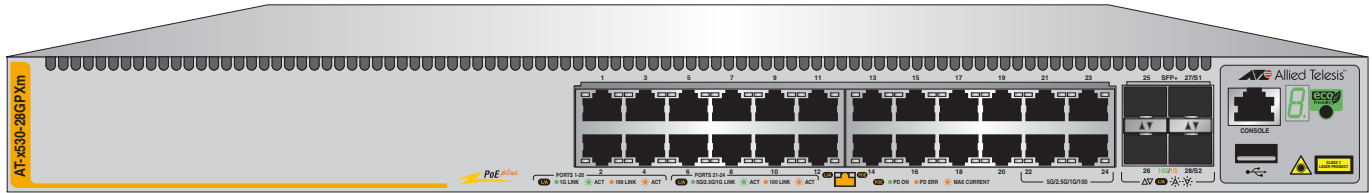
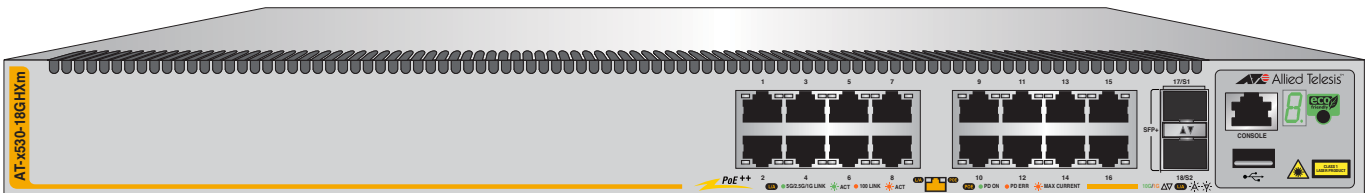
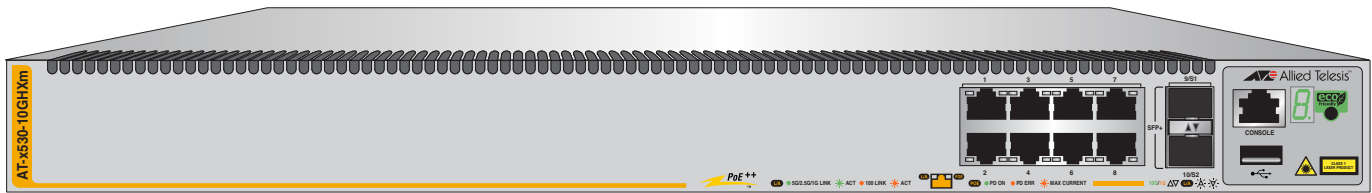

# Installation Guide for Virtual Chassis Stacking

Copyright © 2023 Allied Telesis, Inc.

All rights reserved. No part of this publication may be reproduced without prior written permission from Allied Telesis, Inc.

Allied Telesis, VCStack, and the Allied Telesis logo are trademarks of Allied Telesis, Incorporated. All other product names, company names, logos or other designations mentioned herein are trademarks or registered trademarks of their respective owners.

Allied Telesis, Inc. reserves the right to make changes in specifications and other information contained in this document without prior written notice. The information provided herein is subject to change without notice. In no event shall Allied Telesis, Inc. be liable for any incidental, special, indirect, or consequential damages whatsoever, including but not limited to lost profits, arising out of or related to this manual or the information contained herein, even if Allied Telesis, Inc. has been advised of, known, or should have known, the possibility of such damages.

# Electrical Safety and Emissions Standards

---

This product meets the following standards.

## U.S. Federal Communications Commission

### Radiated Energy

Note: This equipment has been tested and found to comply with the limits for a Class A digital device pursuant to Part 15 of FCC Rules. These limits are designed to provide reasonable protection against harmful interference when the equipment is operated in a commercial environment. This equipment generates, uses, and can radiate radio frequency energy and, if not installed and used in accordance with this instruction manual, may cause harmful interference to radio communications. Operation of this equipment in a residential area is likely to cause harmful interference in which case the user will be required to correct the interference at his own expense.

Note: Modifications or changes not expressly approved of by the manufacturer or the FCC, can void your right to operate this equipment.

## Industry Canada

This Class A digital apparatus complies with Canadian ICES-003.

Cet appareil numérique de la classe A est conforme à la norme NMB-003 du Canada.

RFI Emissions: FCC part15 Subpart B Class A, ICES-003 Class A, EN55032 Class A, CISPR 32 Class A, VCCI Class A, RCM AS/NZS CISPR 32 Class A

**Warning:** In a domestic environment this product may cause radio interference in which case the user may be required to take adequate measures.

EMC (Immunity): EN55035

Electrical Safety: UL 62368-1, CSA C22.2 No.62368-1, EN IEC 62368-1

Compliance Marks: CE, cUL<sub>US</sub>, TUV, RCM



Laser Safety

EN(IEC) 60825-1

## Translated Safety Statements

---

**Important:** Safety statements that have the  symbol are translated into multiple languages in the *Translated Safety Statements* document at <https://www.alliedtelesis.com/us/en/documents/translated-safety-statements>.

**Remarque:** Les consignes de sécurité portant le symbole  sont traduites dans plusieurs langues dans le document *Translated Safety Statements*, disponible à l'adresse <https://www.alliedtelesis.com/us/en/documents/translated-safety-statements>.



# Contents

---

<b>Preface:</b> .....	13
Document Conventions .....	14
Contacting Allied Telesis .....	15
<b>Chapter 1: Overview</b> .....	17
Front and Rear Panels .....	18
Features .....	21
x530 Models .....	21
Power Over Ethernet .....	22
SFP/SFP+ Transceiver Ports .....	23
LEDs .....	24
Installation Options .....	24
Management Software and Interfaces .....	24
Management Methods .....	25
Management Panel .....	26
Copper Ports .....	27
Duplex Mode .....	33
Wiring Configuration .....	34
Maximum Distance .....	34
Cable Requirements .....	34
Port Pinouts .....	34
Power Over Ethernet .....	35
PoE Standards .....	35
Powered Device Classes .....	36
Power Budget .....	36
Port Prioritization .....	37
Wiring Implementation .....	38
eco-friendly Button .....	39
LEDs .....	40
LEDs for the SFP Ports .....	49
S1 and S2 SFP+ Port LEDs .....	50
Switch ID LED .....	52
VCStack Feature .....	54
USB Port .....	55
Console Port .....	56
Power Supplies .....	57
Software and Hardware Releases .....	58
<b>Chapter 2: Virtual Chassis Stacking</b> .....	59
Overview .....	60
Stacking Guidelines .....	61
Stack Trunks .....	63
Stack Trunks of the Default 10Gbps SFP+ S1 and S2 Stacking Ports .....	64
Stack Trunks of 5Gbps Copper Ports .....	69
Stack Trunks of 1Gbps Copper Ports .....	72
Stack Trunks of 1Gbps SFP Ports 1 to 24 on x530-28GSX Switches .....	74
Invalid Stack Trunks .....	76
Example 1 .....	76
Example 2 .....	76
Example 3 .....	77

Example 4.....	77
Master and Member Switches .....	78
Selection of the Master Switch .....	78
Switch ID Numbers .....	80
Optional Feature Licenses .....	81
Mixed Switch Stacks .....	82
Stack Mixed-Mode Licenses .....	82
Stack Mixed-Mode Commands.....	83
Trunk Ports .....	83
Optional Licenses .....	83
AlliedWare Plus .....	83
Guidelines.....	83
Planning the Stack.....	85
Configuring Mixed-Mode VCStacking.....	86
Stacking Worksheet.....	87
<b>Chapter 3: Beginning the Installation .....</b>	<b>91</b>
Reviewing Safety Precautions .....	92
Choosing a Site for the Switch.....	97
Unpacking the Switch .....	98
<b>Chapter 4: Installing the Switch on a Table .....</b>	<b>103</b>
Installing the Rubber Feet on the Switch .....	104
Installing the Bumper Feet with Rivets on the Switch.....	105
Placing the Switch on a Desk or Table .....	108
<b>Chapter 5: Installing the Switch in an Equipment Rack .....</b>	<b>109</b>
Beginning the Installation.....	110
Required Items .....	110
Switch Orientations in the Equipment Rack.....	110
Installing the Switch .....	112
<b>Chapter 6: Installing the Switch on a Wall .....</b>	<b>115</b>
Switch Orientations on a Wall.....	116
Installation Guidelines.....	118
Tools and Material .....	118
Plywood Base for a Wall with Wooden Studs.....	120
Installing a Plywood Base.....	121
Installing the Switch on a Plywood Base .....	122
Installing the Switch on a Concrete Wall.....	127
<b>Chapter 7: Building the Trunk with the Default SFP+ S1 and S2 10Gbps Stacking Ports .....</b>	<b>131</b>
Introduction .....	132
Powering On the Switches Sequentially .....	133
Powering On the Switches Simultaneously .....	136
Starting a Management Session.....	138
Through the Console Port .....	138
With a DHCP or DHCPv6 Server.....	140
Without a DHCP or DHCPv6 Server.....	141
Verifying the Stack.....	143
Adding SFP+ Ports to the Stack Trunk.....	144
Powering on a Switch .....	146
<b>Chapter 8: Building the Stack with Gigabit or 5G Multi-speed Ports .....</b>	<b>149</b>
Introduction .....	150
Command Summary .....	151
STACK ENABLE Command .....	151
STACKPORT Command .....	151
STACK PRIORITY Command .....	151
STACK RENUMBER Command.....	153
SWITCH PROVISION Command.....	153
Configuring the Master Switch .....	154
General Steps for the Master Switch.....	155

Configuring the Master Switch - Part I.....	156
Configuring the Master Switch - Part II.....	158
Verifying the Master Switch.....	160
What to Do Next.....	162
Configuring Member Switches.....	163
General Steps for the Member Switch.....	163
Configuring Member Switches - Part I.....	164
Configuring Member Switches - Part II.....	165
Verifying Member Switches.....	167
What to Do Next.....	169
Powering on the Stack.....	170
Verifying the Stack.....	171
<b>Chapter 9: Cabling the Networking Ports</b> .....	<b>173</b>
Cabling Copper Ports.....	174
Installing SFP and SFP+ Transceivers.....	176
Installing SP10TW Direct Connect Cables.....	180
<b>Chapter 10: Troubleshooting</b> .....	<b>183</b>
<b>Appendix A: Technical Specifications</b> .....	<b>189</b>
Physical Specifications.....	190
Dimensions.....	190
Weights.....	192
Ventilation.....	193
Environmental Specifications.....	194
Power Specifications.....	195
Maximum Power Consumption.....	195
Input Voltages.....	195
Heat Dissipation.....	196
RJ-45 Copper Port Pinouts.....	197
RJ-45 Style Serial Console Port Pinouts.....	198
USB Port.....	199



# Figures

---

Figure 1: Front Panel of the x530-10GHXm Switch.....	18
Figure 2: Front Panel of the x530-18GHXm Switch.....	18
Figure 3: Front Panel of the x530-28GTXm Switch.....	18
Figure 4: Front Panel of the x530-28GPXm Switch.....	19
Figure 5: Front Panel of the x530-28GSX Switch.....	19
Figure 6: Front Panel of the x530-52GTXm Switch.....	19
Figure 7: Front Panel of the x530-52GPXm Switch.....	20
Figure 8: Back Panel of the x530-10GHXm, x530-18GHXm, x530-28GPXm, and x530-52GPXm PoE Switches .....	20
Figure 9: Back Panel of the x530-28GSX, x530-28GTXm and x530-52GTXm Non-PoE Switches .....	20
Figure 10: Management Panel .....	26
Figure 11: x530-10GHXm Copper Ports.....	40
Figure 12: x530-18GHXm Copper Ports.....	41
Figure 13: x530-28GTXm and x530-52GTXm Copper Ports LEDs.....	43
Figure 14: x530-28GPXm and x530-52GPXm Copper Ports LEDs .....	45
Figure 15: SFP Port LEDs on the x530-28GSX Switch .....	49
Figure 16: Link and Activity LEDs for the 1Gbps/10Gbps SFP+ Ports.....	51
Figure 17: Switch ID LED .....	52
Figure 18: Switch ID LED Description .....	53
Figure 19: Stack Trunks of Default S1 and S2 Ports.....	65
Figure 20: Stack Trunks Using all Four Ports.....	67
Figure 21: 10Gbps Stack Trunk with Both SFP+ Fiber Optic Transceivers and SP10TW Direct Connect Cables .....	68
Figure 22: Trunks of 5Gbps Multi-speed Ports for Stacks of Two Switches.....	70
Figure 23: Trunks of 5Gbps Ports for Stacks of Three Switches.....	71
Figure 24: Stack Trunks of 1Gbps Copper Ports.....	73
Figure 25: Trunks of 1Gbps SFP Copper Ports for Stacks of Three x530-28GSX Switches .....	75
Figure 26: Invalid Stack Trunk with an Intermediary Networking Device.....	76
Figure 27: Invalid Stack Trunk with One Port Used Per Switch.....	76
Figure 28: Invalid Stack Trunk with Different Numbers of Links .....	77
Figure 29: Invalid Stack Trunk with Different Port Types.....	77
Figure 30: Switch Shipping Box.....	98
Figure 31: Accessory Kit Items.....	99
Figure 32: Accessory Kit Items.....	100
Figure 33: Parts of the Bumper Feet .....	105
Figure 34: Holes for Bumper Feet .....	106
Figure 35: Inserting the Rivet Housing into the Bumper Foot.....	106
Figure 36: Placing the Bumper Foot on a Base Corner Hole .....	107
Figure 37: Inserting the Rivet into the Bumper Foot.....	107
Figure 38: Bracket Holes on the Switch.....	110
Figure 39: Switch Orientations in an Equipment Rack .....	111
Figure 40: Example of Attaching the Brackets to the Switch.....	112
Figure 41: Installing the Switch in an Equipment Rack.....	113
Figure 42: Positioning the x530-28GTXm or x530-28GSX Switch on the Wall .....	116
Figure 43: Positioning the x530-10GHXm, x530-18GHXm, x530-28GPXm, x530-52GTXm, or x530-52GPXm Switch on the Wall .....	117
Figure 44: Switch on the Wall with a Plywood Base.....	120
Figure 45: Installing the Plywood Base to the Wall.....	121
Figure 46: Installing Two Brackets on the x530-28GTXm or x530-28GSX Switch.....	123
Figure 47: Installing Four Brackets on the x530-10GHXm, x530-18GHXm, x530-28GPXm, x530-52GTXm or x530-52GPXm Switch .....	124

Figures

Figure 48: Securing the x530-28GTXm or x530-28GSX Switch to the Plywood Base .....	125
Figure 49: Securing the x530-10GHXm, x530-18GHXm, x530-28GPXm, x530-52GTXm or x530-52GPXm Switch to the Plywood Base.....	126
Figure 50: Marking the Locations of the Bracket Holes on a Concrete Wall.....	128
Figure 51: Installing the Switch on a Concrete Wall .....	129
Figure 52: Management Cable Included with Switch.....	138
Figure 53: VT-Kit3 Management Cable .....	138
Figure 54: , VT-Kit3 Management Cable with Workstation and Switch .....	139
Figure 55: SHOW STACK Command.....	143
Figure 56: Installing the Power Cord Retaining Clips .....	146
Figure 57: Connecting the AC Power Cord to the Switch .....	147
Figure 58: Plugging in the AC Power Cord to the Switch .....	147
Figure 59: Plugging in the AC Power Cord to an AC Sources.....	148
Figure 60: SHOW STACK Command on the Master Switch .....	160
Figure 61: SHOW RUNNING-CONFIG INTERFACE Command on the Master Switch .....	161
Figure 62: Powering Off the Switch .....	162
Figure 63: SHOW STACK Command for a Member Switch .....	167
Figure 64: SHOW RUNNING-CONFIG INTERFACE Command for Member Switches .....	168
Figure 65: Removing the Dust Plug from an SFP+ Port .....	177
Figure 66: Installing SFP+ Transceivers.....	178
Figure 67: Removing the Dust Cover from an SFP or SFP+ Transceiver .....	178
Figure 68: Positioning the SFP or SFP+ Handle in the Upright Position .....	179
Figure 69: Connecting a Fiber Optic Cable to an SFP or SFP+ Transceiver .....	179
Figure 70: Removing the Dust Cover from the AT-SP10TW Cable.....	180
Figure 71: Installing AT-SP10TW Cables .....	181
Figure 72: x530-10GHXm Dimensions .....	190
Figure 73: x530-18GHXm Dimensions .....	191
Figure 74: x530-28GTXm Dimensions.....	191
Figure 75: x530-28GPXm Dimensions .....	191
Figure 76: x530-28GSX Dimensions .....	191
Figure 77: x530-52GTXm Dimensions.....	192
Figure 78: x530-52GPXm Dimensions .....	192
Figure 79: RJ-45 Socket Pin Layout (Front View).....	197

# Tables

---

Table 1: Basic Features .....	21
Table 2: Copper Port Features .....	27
Table 3: x530-10GHXm Switch Copper Port Specifications .....	28
Table 4: x530-18GHXm Switch Copper Port Specifications .....	29
Table 5: x530-28GTXm Switch Copper Port Specifications .....	30
Table 6: x530-28GPXm Switch Copper Port Specifications .....	31
Table 7: x530-52GTXm Switch Copper Port Specifications .....	32
Table 8: x530-52GPXm Switch Copper Port Specifications .....	33
Table 9: IEEE Powered Device Classes .....	36
Table 10: x530-10GHXm Copper Ports 1 - 8 LED Functions .....	40
Table 11: x530-18GHXm Copper Ports 1 - 16 LED Functions .....	42
Table 12: x530-28GTXm Copper Ports 1 - 24 LED Functions .....	43
Table 13: x530-52GTXm Copper Ports 1 - 48 LED Functions .....	44
Table 14: x530-28GPXm Copper Ports 1 - 24 LED Functions .....	46
Table 15: x530-52GPXm Copper Ports 1 - 48 LED Functions .....	48
Table 16: x530-28GSX SFP Network / Stacking LEDs .....	50
Table 17: Link and Activity Status LEDs for the 1Gbps and 10Gbps Ports .....	52
Table 18: Software and Hardware Releases .....	58
Table 19: Trunk Ports .....	63
Table 20: Stacking Worksheet .....	87
Table 21: Stacking Worksheet Columns .....	88
Table 22: Accessory Kit Items .....	101
Table 23: Adding SFP+ Ports to the Default SFP+ Trunk .....	144
Table 24: Configuring the Master Switch to Use Gigabit or Multi-speed 5G Ports as the Stack Trunk - Part I .....	156
Table 25: Configuring the Master Switch to Use Gigabit or 5G Multi-speed Ports as the Stack Trunk - Part II .....	158
Table 26: Configuring Member Switches - Part I .....	164
Table 27: Configuring Member Switches - Part II .....	165
Table 28: Product Dimensions .....	190
Table 29: Product Weights .....	192
Table 30: Ventilation Requirements .....	193
Table 31: Environmental Specifications .....	194
Table 32: Maximum Power Consumptions .....	195
Table 33: Input Voltages .....	195
Table 34: Heat Dissipation .....	196
Table 35: Pin Signals for 100M/1G/2.5G/5G Base-T Connectors .....	197
Table 36: RJ-45 Style Serial Console Port Pin Signals .....	198
Table 37: USB Port Pin Signals .....	199





# Preface

---

This guide contains the installation instructions for the x530 Series of stackable Gigabit, Layer 3 Ethernet switches. This preface contains the following sections:

- “Document Conventions” on page 14
- “Contacting Allied Telesis” on page 15

---

**Note**

This guide explains how to install switches as a stack with Virtual Chassis Stacking (VCStack™). For instructions on how to install the devices as standalone switches, refer to the *x530 Series Installation Guide for Standalone Switches*.

---

## Document Conventions

---

This document uses the following conventions:

---

**Note**

Notes provide additional information.

---



---

**Caution**

Cautions inform you that performing or omitting a specific action may result in equipment damage or loss of data.

---



---

**Warning**

Warnings inform you that performing or omitting a specific action may result in bodily injury.

---

## Contacting Allied Telesis

---

If you need assistance with this product, you may contact Allied Telesis technical support by going to the Services & Support section of the Allied Telesis web site at <https://www.alliedtelesis.com/us/en/services/support-services>. You can find links for the following services on the bottom of this page:

- ❑ Helpdesk (Support Portal) - Log onto Allied Telesis interactive support center to search for answers to your questions in our knowledge database, check support tickets, learn about Return Merchandise Authorizations (RMAs), and contact Allied Telesis technical experts.
- ❑ Software Downloads - Download the latest software releases for your product.
- ❑ Licensing - Register and obtain your License key to activate your product or feature.
- ❑ Product Documents - View the most recent installation guides, user guides, software release notes, white papers and data sheets for your product.
- ❑ Warranty - View a list of products to see if Allied Telesis warranty applies to the product you purchased and register your warranty.

To contact a sales representative or find Allied Telesis office locations, go to <https://www.alliedtelesis.com/us/en/contact>.



# Chapter 1

# Overview

---

This chapter contains the following sections:

- ❑ “Front and Rear Panels” on page 18
- ❑ “Features” on page 21
- ❑ “Management Panel” on page 26
- ❑ “Copper Ports” on page 27
- ❑ “Power Over Ethernet” on page 35
- ❑ “eco-friendly Button” on page 39
- ❑ “LEDs” on page 40
- ❑ “VCStack Feature” on page 54
- ❑ “USB Port” on page 55
- ❑ “Console Port” on page 56
- ❑ “Power Supplies” on page 57
- ❑ “Software and Hardware Releases” on page 58

---

### **Note**

This guide explains how to install switches as a stack with Virtual Chassis Stacking (VCStack™). For instructions on how to install the devices as standalone switches, refer to the *x530 Series Installation Guide for Standalone Switches*.

---

# Front and Rear Panels

The front panels on the x530 Series switches are shown in Figure 1 through Figure 7 on page 20.

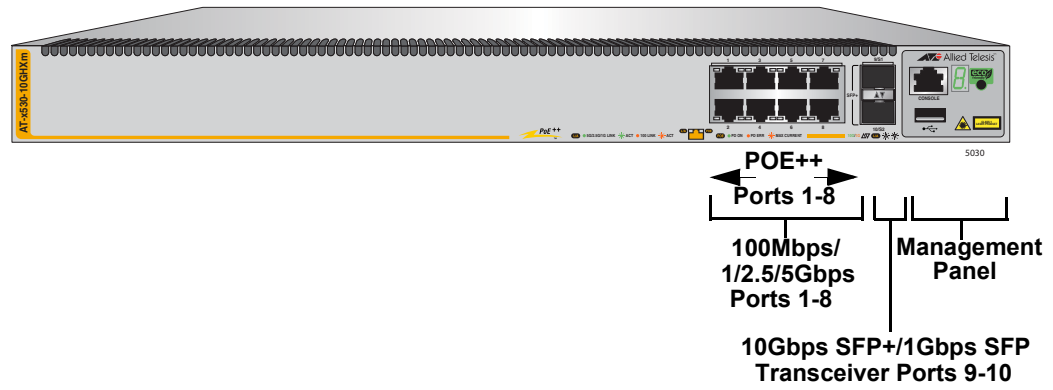

Figure 1. Front Panel of the x530-10GHXm Switch

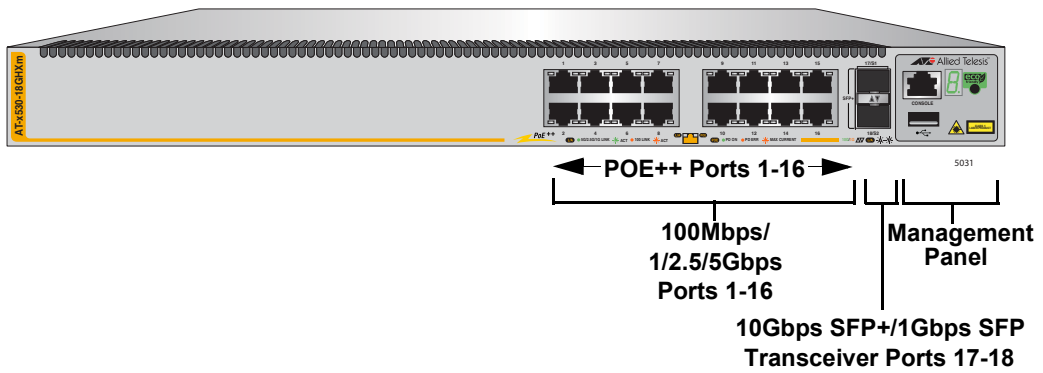

Figure 2. Front Panel of the x530-18GHXm Switch

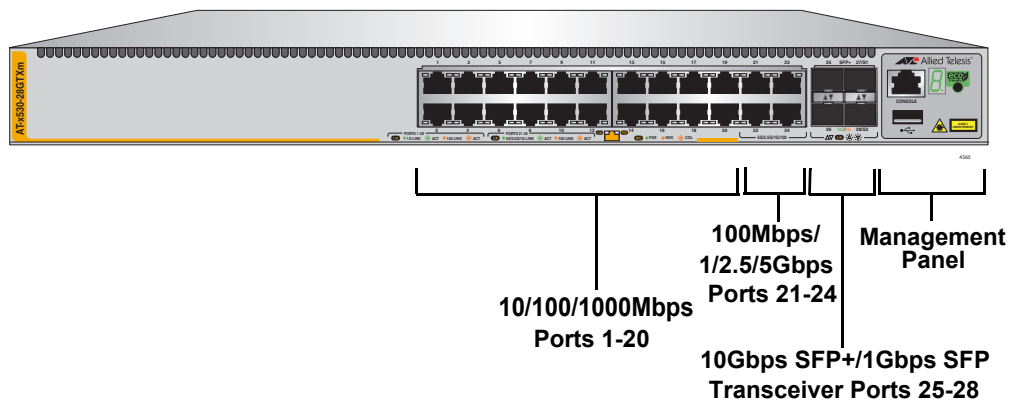

Figure 3. Front Panel of the x530-28GTXm Switch

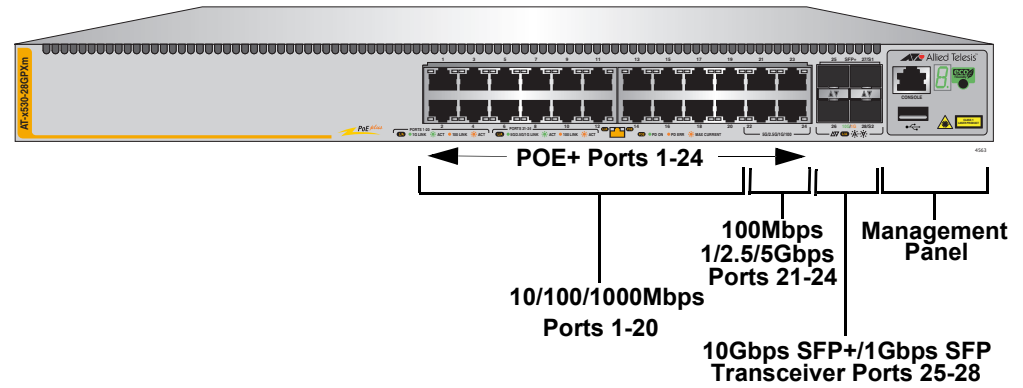

Figure 4. Front Panel of the x530-28GPXm Switch

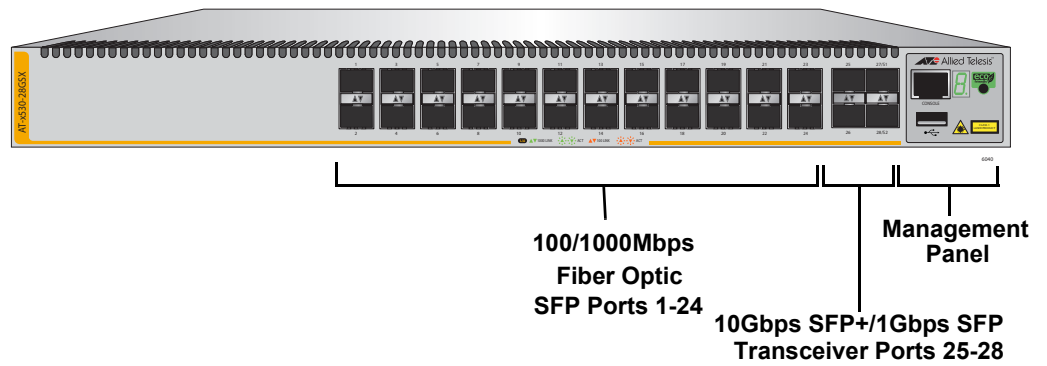

Figure 5. Front Panel of the x530-28GSX Switch

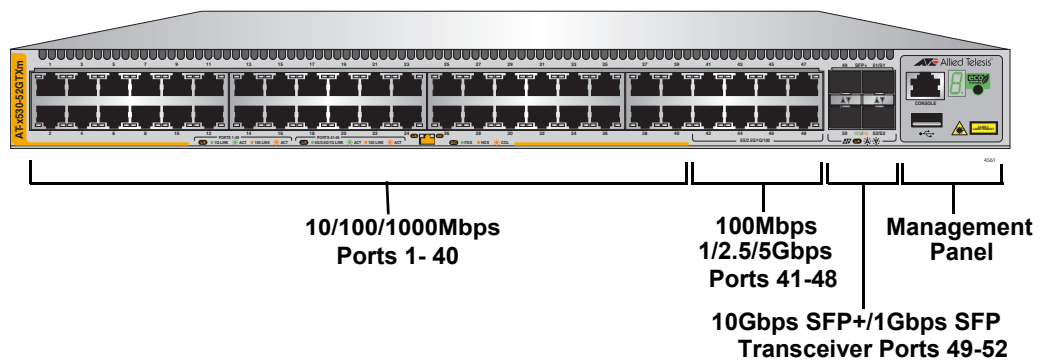

Figure 6. Front Panel of the x530-52GTxm Switch

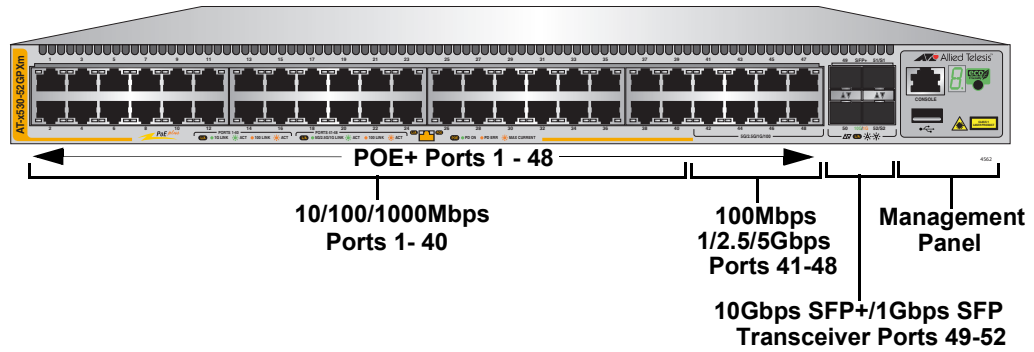

Figure 7. Front Panel of the x530-52GPXm Switch

The back panels of the x530 Series switches are shown in Figure 8 and Figure 9.

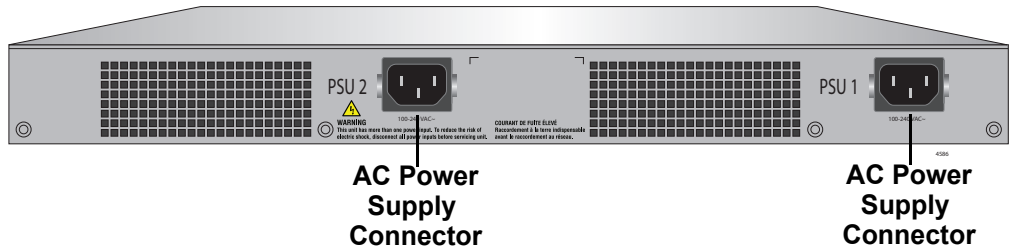

Figure 8. Back Panel of the x530-10GHXm, x530-18GHXm, x530-28GPXm, and x530-52GPXm PoE Switches

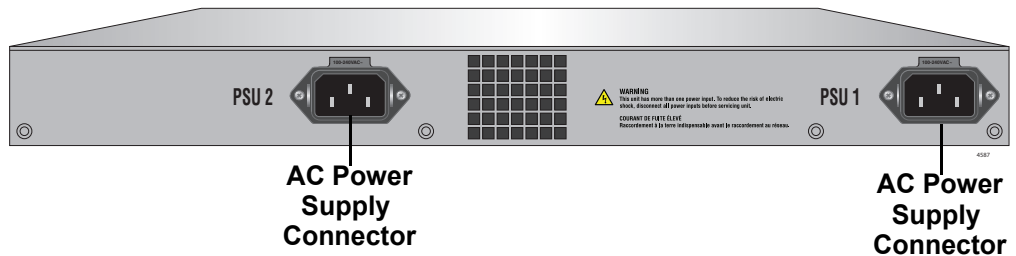

Figure 9. Back Panel of the x530-28GSX, x530-28GTXm and x530-52GTXm Non-PoE Switches



## Features

---

The Allied Telesis x530 Series switches are stackable Gigabit, Layer 3 Ethernet switches. The following sections list the features.

**x530 Models** Table 1 lists the basic features for each switch model.

Table 1. Basic Features

Feature	x530-10GHXm (PoE++)	x530-18GHXm (PoE++)	x530-28GTXm	x530-28GPXm (PoE+)	x530-28GSX	x530-52GTXm	x530-52GPXm (PoE+)
10Mbps, 100Mbps and 1000Mbps Copper Ports (Non-PoE)	-	-	20	-	-	40	-
10Mbps, 100Mbps and 1000Mbps PoE+ Copper Ports	-	-	-	20	-	-	40
100Mbps and 1/2.5/5Gbps Copper Ports (Non-PoE)	-	-	4	-	-	8	-
100Mbps and 1/2.5/5Gbps PoE+ Copper Ports	-	-	-	4	-	-	8
100Mbps and 1/2.5/5Gbps PoE++ Copper Ports	8	16	-	-	-	-	-
1Gbps SFP and 10Gbps SFP+ Transceiver Ports	2	2	4	4	4	4	4
100Mbps and 1Gbps SFP Transceiver Ports	-	-	-	-	24	-	-
VCStack	Yes	Yes	Yes	Yes	Yes	Yes	Yes
Pre-installed Power Supply (Not Field Replaceable)	2	2	2	2	2	2	2

## Power Over Ethernet

The basic features of PoE+ on the copper ports of the x530-28GPXm and x530-52GPXm switches are:

- Supported on all ports.
- Supports PoE (15.4W maximum) and PoE+ (30W maximum) powered devices
- 740W maximum power budget (370W per power supply)
- Supports powered device classes 0 to 4
- Port prioritization
- Mode A wiring
- IEEE802.3af/at compliant

The basic features of PoE++ on the copper ports on the x530-10GHXm switch are:

- Supported on all ports
- 720W maximum power budget (90W x 8 = 720) (500W per power supply):
  - PoE (15.4W maximum) for 8 powered devices
  - PoE+ (30W maximum) for 8 powered devices
  - PoE++ (60W maximum) for 8 powered devices
  - PoE++ (90W maximum) for 8 powered devices
- Supports powered device classes 0 to 8
- Port prioritization
- Mode A and Mode B wiring
- IEEE802.3af/at/bt compliant

The basic features of PoE++ on the copper ports on the x530-18GHXm switch are:

- Supported on all ports
- 1,000W maximum power budget (500W per power supply):
  - PoE (15.4W maximum) for 16 powered devices
  - PoE+ (30W maximum) for 16 powered devices
  - PoE++ (60W maximum) for 16 powered devices
  - PoE++ (90W maximum) for 11 powered devices
- Supports powered device classes 0 to 8
- Port prioritization
- Mode A and Mode B wiring
- IEEE802.3af/at/bt compliant

## SFP/SFP+ Transceiver Ports

The SFP transceivers slots (ports 1 to 24) on the x530-28GSX switch support the following types of transceivers:

- ❑ 100Mbps/1Gbps SFP transceivers

The four SFP+ transceiver slots in the x530-28GTXm, x530-28GPXm, and x530-28GSX switches (ports 25-28), and x530-52GTXm and x530-52GPXm switches (ports 49-52) support the following types of transceivers:

- ❑ 1Gbps SFP transceivers
- ❑ 10Gbps SFP+ transceivers

The SFP+ transceiver ports on the x530-28GSX switch support 10Gbps BiDi transceivers.

An example of SFP 100Mbps/1Gbps transceivers include:

- ❑ SPFX series are 100Mbps supported SFP transceivers.
- ❑ SPSX and LR short and long distance transceivers using multi-mode or single mode fiber optic cable.
- ❑ SPBD series of bidirectional transceivers with maximum distances of 10 and 40 kilometers.

Examples of SFP+ 10Gbps transceivers include:

- ❑ SP10BD bidirectional transceivers for single mode fiber optic cable with a maximum distance of 10 kilometers.
- ❑ SP10SR, LR, ER and ZR series of short or long distance transceivers using multi-mode or single mode fiber optic cable.
- ❑ SP10TM 1/2.5/5/10G transceiver with RJ-45 connector for a copper link of up to 30m with Category 6a or 7 cable, or 100m with Category 5e cable up to 5G.
- ❑ SP10T transceiver with RJ-45 connector for links up to 20 meters at 10Gbps with Category 6a or better copper cable, or 100 meters at 1Gbps.

---

### Note

SFP and SFP+ transceivers must be purchased separately. For a list of supported transceivers, contact your Allied Telesis distributor or reseller.

---



---

### Note

Industrial (-40 to 85° C) and extended (-40 to 105° C) temperature transceivers are available.

---

---

**Note**

The switches do not support the 7-meter AT-SP10TW7 direct attach cable.

---

---

**Note**

For a current list of supported transceiver modules refer to the *x530 Series Data Sheet*.

---

The following restrictions on SFP+ transceivers apply:

- 100Mbps transceivers are not supported
- Supports full-duplex mode only

**LEDs**

The port LEDs are:

- Link/activity LEDs for the copper ports on all switches
- Link/activity LEDs for the SFP and SFP+ transceiver ports on all switches
- Full/Half/Collision LEDs for the copper ports on the x530-28GTXm and x530-52GTXm switches
- PoE+ LEDs for the copper ports on the x530-28GPXm and x530-52GPXm switches
- PoE++ LEDs for the copper ports on the x530-10GHXm and x530-18GHXm switches
- Switch ID number LED

**Installation Options**

The installation options are:

- Desk or tabletop
- 19-inch equipment rack
- Wood or concrete wall

**Management Software and Interfaces**

The management software and interfaces are:

- AlliedWare Plus Management Software
- Command line interface (CLI)

## **Management Methods**

The following methods are used for managing the switches:

- Local management through the Console port
- Remote Telnet or Secure Shell management
- Vista Manager mini
- Autonomous Management Framework (AMF) with Vista Manager EX
- Autonomous Wave Controller (AWC) for wireless networks
- SNMPv1, v2c, and v3

# Management Panel

---

Figure 10 identifies the components on the management panel.

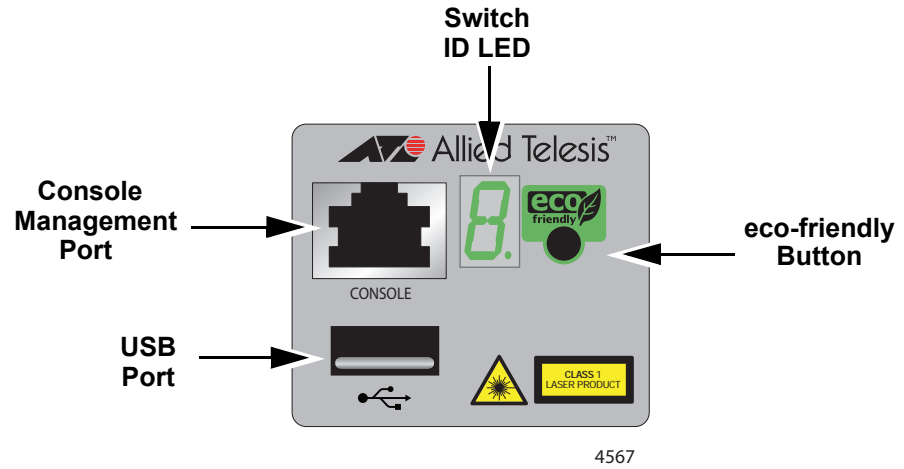

Figure 10. Management Panel

## Copper Ports

Table 2 lists the copper ports features for each switch model.

Table 2. Copper Port Features

Feature	x530-10GHXm (PoE++)	x530-18GHXm (PoE++)	x530-28GTXm	x530-28GPXm (PoE+)	x530-52GTXm	x530-52GPXm (PoE+)
Ports 1 to 8 support 100Mbps and 1/2.5/5Gbps operation	Yes	-	-	-	-	-
Ports 1 to 16 support 100Mbps and 1/2.5/5Gbps operation	-	Yes	-	-	-	-
Ports 1 to 20 support 10/100/1000Mbps operation	-	-	Yes	Yes	-	-
Ports 21 to 24 support 100Mbps and 1/2.5/5Gbps operation	-	-	Yes	Yes	-	-
Ports 1 to 40 support 10/100/1000Mbps operation	-	-	-	-	Yes	Yes
Ports 41 to 48 support 100Mbps and 1/2.5/5Gbps operation	-	-	-	-	Yes	Yes
100 meters (328 feet) maximum operating distance per port	Yes	Yes	Yes	Yes	Yes	Yes
Auto-Negotiation for speed	Yes	Yes	Yes	Yes	Yes	Yes
Full-duplex mode only	Yes	Yes	Yes	Yes	Yes	Yes
MDI/MDI-X at 10Mbps and 100Mbps	Yes	Yes	Yes	Yes	Yes	Yes
Port Link/Activity (L/A) and Duplex/ Collision (D/C) LEDs	-	-	Yes	-	Yes	-
Power over Ethernet (PoE++) supported on all ports	Yes	Yes	-	-	-	-
Power over Ethernet (PoE+) supported on all ports	Yes	Yes	-	Yes	-	Yes
Port Link/Activity (L/A) and Power over Ethernet (PoE) LEDs	Yes	Yes	-	Yes	-	Yes

The specifications of the copper ports are listed in:

- ❑ Table 3 for the x530-10GHXm switch, next
- ❑ Table 4 on page 29 for the x530-18GHXm switch
- ❑ Table 5 on page 30 for the x530-28GTXm switch
- ❑ Table 6 on page 31 for the x530-28GPXm switch
- ❑ Table 7 on page 32 for the x530-52GTXm switch
- ❑ Table 8 on page 33 for the x530-52GPXm switch.

Table 3. x530-10GHXm Switch Copper Port Specifications

Specification	Description
Port Speed	Ports 1 - 8: 100Mbps or 1/2.5/5Gbps. 100Mbps: Set the port speed manually or with Auto-Negotiation. 1/2.5/5Gbps: The port speed is set with Auto-Negotiation only. The default is Auto-Negotiation for all ports.
Duplex Mode	Ports 1 - 8: 100Mbps: Full- or half-duplex mode. 1/2.5/5Gbps: Full-duplex mode only. Supports Auto-Negotiation at 100Mbps.
Maximum Distance	100 meters (328 feet)
Power over Ethernet	<ul style="list-style-type: none"> <li>❑ PoE (15.4W maximum per port) / 8 PDs</li> <li>❑ PoE+ (30W maximum per port) / 8 PDs</li> <li>❑ PoE++(60W maximum per port) / 8 PDs</li> <li>❑ PoE++(90W maximum per port) / 8 PDs</li> </ul>
Maximum Power Budget	720W maximum power budget (90W x 8 = 720) (500W per power supply)
PoE Mode	Classes 0 to 8: Mode A and B (all eight strands)
Connector	8-pin RJ-45



Table 4. x530-18GHXm Switch Copper Port Specifications

Specification	Description
Port Speed	Ports 1 - 16: 100Mbps or 1/2.5/5Gbps. 100Mbps: Set the port speed manually or with Auto-Negotiation. 1/2.5/5Gbps: The port speed is set with Auto-Negotiation only. The default is Auto-Negotiation for all ports.
Duplex Mode	Ports 1 - 16: 100Mbps: Full- or half-duplex mode. 1/2.5/5Gbps: Full-duplex mode only. Supports Auto-Negotiation at 100Mbps.
Maximum Distance	100 meters (328 feet)
Power over Ethernet	<input type="checkbox"/> PoE (15.4W maximum per port) / 16 PDs <input type="checkbox"/> PoE+ (30W maximum per port) / 16 PDs <input type="checkbox"/> PoE++(60W maximum per port) / 16 PDs <input type="checkbox"/> PoE++(90W maximum per port) / 11 PDs
Maximum Power Budget	1,000W (500W per power supply)
PoE Mode	Classes 0 to 8: Mode A and B (all eight strands)
Connector	8-pin RJ-45

Table 5. x530-28GTXm Switch Copper Port Specifications

Specification	Description
Port Speed	<p>Ports 1 - 20: 10Mbps/100Mbps/1000Mbps. Ports 21 - 24: 100Mbps or 1/2.5/5Gbps</p> <p>Ports 1 - 20: Set the port speed manually or with Auto-Negotiation at 10Mbps and 100Mbps.</p> <p>Ports 21 - 24: The port speed is set with Auto-Negotiation only, at 1Gbps and higher.</p> <p>The default is Auto-Negotiation for all ports.</p>
Duplex Mode	<p>Ports 1 - 20: Full- or half-duplex mode at 10Mbps and 100Mbps. Full-duplex only at 1Gbps. Supports Auto-Negotiation at 10Mbps and 100Mbps.</p> <p>Ports 21- 24: Full-duplex only at all speeds.</p>
Maximum Distance	100 meters (328 feet).
Connector	8-pin RJ-45.

Table 6. x530-28GPXm Switch Copper Port Specifications

Specification	Description
Port Speed	<p>Ports 1 - 20: 10Mbps/100Mbps/1000Mbps. Ports 21 - 24: 100Mbps or 1/2.5/5Gbps</p> <p>Ports 1 - 20: Set the port speed manually or with Auto-Negotiation at 10Mbps and 100Mbps.</p> <p>Ports 21 - 24: The port speed is set with Auto-Negotiation only, at 1Gbps and higher.</p> <p>The default is Auto-Negotiation for all ports.</p>
Duplex Mode	<p>Ports 1 - 20: Full- or half-duplex mode at 10Mbps and 100Mbps. Full-duplex only at 1Gbps. Supports Auto-Negotiation at 10Mbps and 100Mbps.</p> <p>Ports 21- 24: Full-duplex only at all speeds.</p>
Maximum Distance	100 meters (328 feet).
Power over Ethernet	PoE (15.4W maximum per port) and PoE+ (30W maximum per port).
Maximum Power Budget	740W (370W per power supply).
PoE Mode	Mode A.
Connector	8-pin RJ-45.

Table 7. x530-52GTXm Switch Copper Port Specifications

Specification	Description
Port Speed	<p>Ports 1 - 40: 10Mbps/100Mbps/1000Mbps. Ports 41 - 48: 100Mbps or 1/2.5/5Gbps</p> <p>Ports 1 - 40: Set the port speed manually or with Auto-Negotiation at 10Mbps, and 100Mbps.</p> <p>Ports 41 - 48: The port speed is set with Auto-Negotiation only, at 1Gbps and higher.</p> <p>The default is Auto-Negotiation for all ports.</p>
Duplex Mode	<p>Ports 1 - 40: Full- or half-duplex mode at 10Mbps or 100Mbps. Full-duplex only at 1Gbps. Supports Auto-Negotiation at 10Mbps and 100Mbps.</p> <p>Ports 41- 48: Full-duplex only at all speeds.</p>
Maximum Distance	100 meters (328 feet).
Connector	8-pin RJ-45.

Table 8. x530-52GPXm Switch Copper Port Specifications

Specification	Description
Port Speed	<p>Ports 1 - 40: 10Mbps/100Mbps/1000Mbps. Ports 41 - 48: 100Mbps or 1/2.5/5Gbps</p> <p>Ports 1 - 40: Set the port speed manually or with Auto-Negotiation at 10Mbps, and 100Mbps.</p> <p>Ports 41 - 48: The port speed is set with Auto-Negotiation only, at 1Gbps and higher.</p> <p>The default is Auto-Negotiation for all ports.</p>
Duplex Mode	<p>Ports 1 - 40: Full- or half-duplex mode at 100Mbps. Full-duplex only at 1Gbps. Supports Auto-Negotiation at 10Mbps and 100Mbps.</p> <p>Ports 41- 48: Full-duplex only at all speeds.</p>
Maximum Distance	100 meters (328 feet).
Power over Ethernet	PoE (15.4W maximum per port) and PoE+ (30W maximum per port).
Maximum Power Budget	740W (370W per power supply).
PoE Mode	Mode A.
Connector	8-pin RJ-45.

## Duplex Mode

The copper ports can operate in either half- or full-duplex mode at 10Mbps or 100Mbps and full-duplex only at higher speeds.

The duplex mode of a port operating at 10Mbps or 100Mbps, like port speed, can be set manually using the management software or automatically with Auto-Negotiation (IEEE 802.3u), the default setting.

The speed and duplex mode settings of a port can be set independently of each other. For example in the case of a 10Mbps or 100Mbps port, it can be configured such that its speed is set manually while its duplex mode is established through Auto-Negotiation.

---

**Note**

Switch ports default to half-duplex mode when connected to 10Mbps or 100Mbps network devices that do not support Auto-Negotiation. If a network device supports full-duplex only, a duplex mode mismatch can occur, resulting in poor network performance. To prevent this, disable Auto-Negotiation and set the duplex mode manually on ports connected to 10Mbps or 100Mbps devices that support full-duplex only.

---

**Wiring Configuration**

The wiring configuration of a port operating at 10Mbps or 100Mbps can be MDI or MDI-X. The wiring configurations of a switch port and a network device connected with straight-through copper cabling must be opposite, such that one device is using MDI and the other MDI-X. For example, a switch port must be set to MDI-X if it is connected to a network device set to MDI.

The wiring configurations of the ports can be set manually or automatically by the switch with auto-MDI/MDI-X (IEEE 802.3ab-compliant). This feature enables the switch to automatically negotiate with network devices to establish their proper settings.

The MDI and MDI-X settings do not apply when ports are operating at a speed of 1Gbps or higher.

**Maximum Distance**

The ports have a maximum operating distance of 100 meters (328 feet).

**Cable Requirements**

The minimum copper cable requirements are as follows:

- ❑ 10/100Mbps ports: Standard TIA/EIA 568-B-compliant Category 3 unshielded cabling
- ❑ 1Gbps ports: Standard TIA/EIA 568-A-compliant Category 5 or TIA/EIA 568-B-compliant Enhanced Category 5 (Cat 5e)
- ❑ 2.5/5Gbps ports: Standard TIA/EIA 568-A-compliant Category 6 or TIA/EIA 568-B-compliant Category 6A (Cat 6A) unshielded cabling

**Port Pinouts**

Refer to Table 35 on page 197 for the port pinouts of the 100Mbps and 1/2.5/5Gbps copper ports.

## Power Over Ethernet

---

The x530-10GHXm, x530-18GHXm, x530-28GPXm and x530-52GPXm switches feature PoE on copper ports. With PoE, the switches supply DC power to network devices over the same copper cables that carry the network traffic.

PoE can make it easier to install networks. The selection of a location for a network device can be limited by whether there is a power source nearby. This often limits equipment placement or requires the added time and cost of having additional electrical sources installed. With PoE, you can install PoE-compatible devices wherever they are needed without having to worry about whether there are power sources nearby.

A device that provides PoE to network devices is referred to as *power sourcing equipment* (PSE). It functions as a central power source for other network devices.

Devices that receive their power from a PSE are called *powered devices* (PD). Examples include wireless access points, IP telephones, webcams, and even other Ethernet switches.

The x530-10GHXm, x530-18GHXm, x530-28GPXm and x530-52GPXm switches automatically determine whether devices connected to their ports are powered devices. Ports that are connected to network nodes that are not powered devices (that is, devices that receive their power from another power source) function as regular Ethernet ports, without PoE. The PoE feature remains activated on the ports but no power is delivered to the devices.

### PoE Standards

The x530-10GHXm, x530-18GHXm, x530-28GPXm and x530-52GPXm switches support these PoE standards:

- ❑ PoE (IEEE 802.3af): This standard provides up to 15.4 watts at the switch port for powered devices that require up to 13.0 watts.
- ❑ PoE+ (IEEE 802.3at): This standard provides up to 30.0 watts at the switch port for powered devices that require up to 25.5 watts.

The x530-10GHXm and x530-18GHXm switches support this additional PoE standard:

- ❑ PoE++ (IEEE 802.3bt): This standard provides up to 90.0 watts at the switch port for powered devices that require up to 71.0 watts.

## Powered Device Classes

Powered devices are grouped into the nine classes listed in Table 9. The classes are based on the amount of power the devices require. The x530-28GPXm and x530-52GPXm switches support classes 0 to 4. The x530-10GHXm and x530-18GHXm switches support classes 0 to 8.

Table 9. IEEE Powered Device Classes

Class	Maximum Power Output from a Switch Port	PD Power Range
0	15.4W	0.44W to 13.0W
1	4.0W	0.44W to 3.84W
2	7.0W	3.84W to 6.49W
3	15.4W	6.49W to 13.0W
4	30.0W	13.0W to 25.5W
5	45.0W	40.0W (4-pair)
6	60.0W	51.3W (4-pair)
7	75.0W	62.0W (4-pair)
8	90.0W	71.3W (4-pair)



### Caution

When hot-swapping PoE PD Classes 5-8, the integrated circuit (IC) device can be damaged when the Ethernet cable is removed while supplying PoE power. To avoid damage, disable the port with the CLI or power off the unit before removing the cable. **E133**

## Power Budget

The x530-28GPXm and x530-52GPXm switches have two power supplies. Each power supply provides 370W for a total PoE of 740W. This is the total maximum amount of power that the switch can supply to powered devices on the PoE+ copper ports. The number of powered devices that the switches can support at one time will depend on their power requirements. For instance, under normal operating conditions, the switches can support up to 24 Class 4 powered devices with the maximum 25.5W.

The x530-10GHXm and x530-18GHXm switches have two power supplies. Each power supply provides 500W for a total PoE of 1,000W. This is the total maximum amount of power that the switch can supply to powered devices on the PoE++ copper ports. The number of powered devices that the switches can support at one time will depend on their power requirements. For instance, under normal operating conditions, the



x530-10GHXm switch can support Class 8 power devices on all eight of its copper ports, while the x530-18GHXm switch can support up to eleven Class 8 devices.

## **Port Prioritization**

The power requirements of the PoE devices determine the maximum number of devices the switch can support at one time. So long as the total power requirements of the power devices are less than the power budget of the switch, the switch can supply power to all the devices. But if the total power requirements exceed the power budget, the switch denies power to one or more ports using a mechanism referred to as port prioritization.

To determine whether the power requirements of the PoE devices you plan to connect to the switch exceed its power budget, refer to their documentation for their power requirements and add the requirements together. The switch should be able to power all the devices simultaneously as long as the total is below its power budget. If the total exceeds the available power budget, you should consider reducing the number of PoE devices so that all of the devices receive power. Otherwise, the switch powers a subset of the devices, based on port prioritization.

There are three priority levels:

- Critical
- High
- Low

Ports set to the Critical level, the highest priority level, are guaranteed power before any of the ports assigned to the other two priority levels. Ports assigned to the other priority levels receive power only if all the Critical ports are receiving power. Ports that are connected to your most critical powered devices must be assigned to this level. If there is not enough power to support all the ports set to the Critical priority level, power is provided to the ports based on port number, in ascending order.

The High level is the second highest level. Ports set to this level receive power only if all the ports set to the Critical level are already receiving power. If there is not enough power to support all of the ports set to the High priority level, power is provided to the ports based on port number, in ascending order.

The lowest priority level is Low. This is the default setting. Ports set to this level only receive power if all of the ports assigned to the other two levels are already receiving power. As with the other levels, if there is not enough power to support all of the ports set to the Low priority level, power is provided to the ports based on port number, in ascending order.

Power allocation is dynamic. Ports supplying power to powered devices can cease power transmission if the switch power budget is at maximum usage and new powered devices, connected to ports with higher priorities become active.

## Wiring Implementation

The IEEE 802.3af standard defines two methods for delivering DC power over copper cable by a switch to powered devices. These methods are known as Modes A and B, and identify the individual wires that carry the DC power within the cable from the switch to powered devices.

Copper cabling typically consists of eight wires. With 100Base-TX devices, the wires connected to pins 1, 2, 3, and 6 on the RJ-45 connectors carry the network traffic while the wires connected to pins 4, 5, 7, and 8 are unused. At higher speeds, all eight wires are used to carry network data.

It takes four wires to deliver DC power to a powered device. With Mode A, power is delivered on pins 1, 2, 3, and 6. These are the same pins in 10Base-T and 100Base-TX devices that carry the network data. With Mode B, power is provided over the spare wires.

The ports deliver power for device classes:

- ❑ 0 to 4: Mode A – x530-28GPXm and x530-52GPXm
- ❑ 0 to 8: Modes A and B – x530-10GHXm and x530-18GHXm

Powered devices that comply with the IEEE 802.3af standard are required to support both Modes A and B. Classes 0 to 4 legacy devices that do not comply with the standard will work with the switch if they are powered on pins 1, 2, 3, and 6.



### Caution

Disable PoE on ports before connecting or disconnecting copper cables to prevent damaging the switch. Disconnecting Ethernet copper network cables while the switch is providing power to powered devices (PDs) can damage the switch. *see* **E131**

---



### Caution

When hot-swapping PoE PD Classes 5-8, the IC device can be damaged when the Ethernet cable is removed while supplying PoE power. To avoid damage, disable the port with the CLI or power off the unit before removing the cable.

---

## eco-friendly Button

---

The eco-friendly button on the front panel of the switch is used to toggle the port LEDs on or off. You can turn off the LEDs to conserve electricity when you are not monitoring the device. You can also toggle the LEDs with the ECOFRIENDLY LED and NO ECOFRIENDLY LED commands in the Global Configuration mode of the command line interface of the AlliedWare Plus management software.

The switch is operating in a low power mode when the LEDs are turned off. Operating the switch in the low power mode does not interfere with the network operations of the device.

The management software on the switch has a command that blinks the LEDs so that you can quickly and easily identify a specific unit among the devices in an equipment rack. It is the FINDME command. The command works on the switch even if you turned off the LEDs with the eco-friendly button or NO ECOFRIENDLY LED command.

---

### **Note**

Before checking or troubleshooting the network connections to the ports on the switch, you must always check to be sure that the LEDs are on by either pressing the eco-friendly button or issuing the ECOFRIENDLY LED and NO ECOFRIENDLY LED commands in the Global Configuration mode in the command line interface.

---

# LEDs

Each copper port has two LEDs that display the port status.

## x530-10GHXm

The LEDs indicate Link/Activity (L/A) and PoE (PD ON/PD ERR/MAX CURRENT) information. These LEDs are shown in Figure 11.

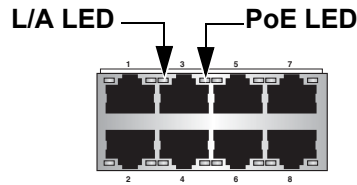

Figure 11. x530-10GHXm Copper Ports

The states of the x530-10GHXm LEDs are described in Table 10.

Table 10. x530-10GHXm Copper Ports 1 - 8 LED Functions

LED	Ports	State	Description
L/A	1 - 8	Solid Green	The port has established a 1/2.5/5Gbps link to a network device.
		Flashing Green	The port is transmitting or receiving data at 1/2.5/5Gbps.
		Solid Amber	The port has established a 100Mbps link to a network device.
		Flashing Amber	The port is transmitting or receiving data at 100Mbps.
		Off	Possible causes of this state are: - The port has not established a link with another network device. - The LEDs are turned off. To turn on the LEDs, use the eco-friendly button.

Table 10. x530-10GHXm Copper Ports 1 - 8 LED Functions (Continued)

LED	Ports	State	Description
PoE++	1-8	Solid Green	PD On - The switch is delivering power to a powered device connected to the port.
		Solid Amber	PD Error - The switch has shut down PoE on the port because of a fault condition.
		Flashing Amber	PD Max Current - The switch has detected a powered device on the port but is not delivering power to it because doing so would exceed its available power budget.
		Off	No PD - This LED state can result from the following conditions: <ul style="list-style-type: none"> <li>- The port is not connected to a powered device or the device is powered off.</li> <li>- The port is disabled in the management software.</li> <li>- PoE is disabled on the port.</li> <li>- The LEDs are turned off. To turn on the LEDs, use the eco-friendly button.</li> </ul>

**x530-18GHXm**

The LEDs indicate Link/Activity (L/A) and PoE (PD ON/PD ERR/MAX CURRENT) information. These LEDs are shown in Figure 12.

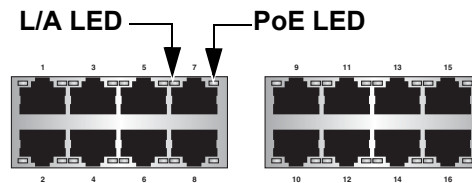

Figure 12. x530-18GHXm Copper Ports

The states of the x530-18GHXm LEDs are described in Table 11 on page 42.

Table 11. x530-18GHXm Copper Ports 1 - 16 LED Functions

LED	Ports	State	Description
L/A	1 - 16	Solid Green	The port has established a 1/2.5/5Gbps link to a network device.
		Flashing Green	The port is transmitting or receiving data at 1/2.5/5Gbps.
		Solid Amber	The port has established a 100Mbps link to a network device.
		Flashing Amber	The port is transmitting or receiving data at 100Mbps.
		Off	<p>Possible causes of this state are:</p> <ul style="list-style-type: none"> <li>- The port has not established a link with another network device.</li> <li>- The LEDs are turned off. To turn on the LEDs, use the eco-friendly button.</li> </ul>
PoE++	1-16	Solid Green	PD On - The switch is delivering power to a powered device connected to the port.
		Solid Amber	PD Error - The switch has shut down PoE on the port because of a fault condition.
		Flashing Amber	PD Max Current - The switch has detected a powered device on the port but is not delivering power to it because doing so would exceed its available power budget.
		Off	<p>No PD - This LED state can result from the following conditions:</p> <ul style="list-style-type: none"> <li>- The port is not connected to a powered device or the device is powered off.</li> <li>- The port is disabled in the management software.</li> <li>- PoE is disabled on the port.</li> <li>- The LEDs are turned off. To turn on the LEDs, use the eco-friendly button.</li> </ul>

### x530-28GTXm and x530-52GTXm

The x530-28GTXm and x530-52GTXm LEDs indicate Link/Activity (L/A) and Duplex/Collision (FDX/HDX/COL) information. These LEDs are shown in Figure 13.

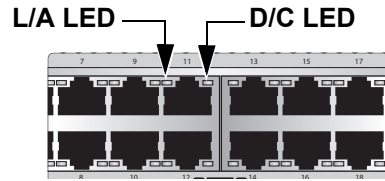

Figure 13. x530-28GTXm and x530-52GTXm Copper Ports LEDs

The states of the x530-28GTXm LEDs are described in Table 12.

Table 12. x530-28GTXm Copper Ports 1 - 24 LED Functions

LED	Ports	State	Description
L/A	1 - 20	Solid Green	The port has established a 1Gbps link to a network device.
		Flashing Green	The port is transmitting or receiving data at 1Gbps.
		Solid Amber	The port has established a 10Mbps or 100Mbps link to a network device.
		Flashing Amber	The port is transmitting or receiving data at 10Mbps or 100Mbps.
	21 - 24	Solid Green	The port has established a 1/2.5/5Gbps link to a network device.
		Flashing Green	The port is transmitting or receiving data at 1/2.5/5Gbps.
		Solid Amber	The port has established a 100 Mbps link to a network device.
		Flashing Amber	The port is transmitting or receiving data at 100Mbps.
		Off	Possible causes of this state are: - The port has not established a link with another network device. - The LEDs are turned off. To turn on the LEDs, use the eco-friendly button.

Table 12. x530-28GTXm Copper Ports 1 - 24 LED Functions (Continued)

LED	Ports	State	Description
D/C	1 - 24	Solid Green	The port is operating in full-duplex mode.
		Solid Amber	The port is operating in half-duplex mode.
		Flashing Amber	The port is operating in half-duplex mode with collisions.

The states of the x530-52GTXm LEDs are described in Table 13.

Table 13. x530-52GTXm Copper Ports 1 - 48 LED Functions

LED	Ports	State	Description
L/A	1 - 40	Solid Green	The port has established a 1Gbps link to a network device.
		Flashing Green	The port is transmitting or receiving data at 1Gbps.
		Solid Amber	The port has established a 10Mbps or 100Mbps link to a network device.
		Flashing Amber	The port is transmitting or receiving data at 10Mbps or 100Mbps.
	41 - 48	Solid Green	The port has established a 1/2.5/5Gbps link to a network device.
		Flashing Green	The port is transmitting or receiving data at 1/2.5/5Gbps.
		Solid Amber	The port has established a 100Mbps link to a network device.
		Flashing Amber	The port is transmitting or receiving data at 100Mbps.
		Off	Possible causes of this state are: <ul style="list-style-type: none"> <li>- The port has not established a link with another network device.</li> <li>- The LEDs are turned off. To turn on the LEDs, use the eco-friendly button.</li> </ul>



Table 13. x530-52GTXm Copper Ports 1 - 48 LED Functions (Continued)

LED	Ports	State	Description
D/C	1 - 48	Solid Green	The port is operating in full-duplex mode.
		Solid Amber	The port is operating in half-duplex mode.
		Flashing Amber	The port is operating in half-duplex mode with collisions.

**Note**

See “SFP/SFP+ Transceiver Ports” on page 23 for descriptions of the LEDs for the SFP/SDP+ ports.

**x530-28GPXm and x530-52GPXm**

The x530-28GPXm and x530-52GPXm LEDs indicate Link/Activity (L/A) and PoE (PD ON/PD ERR/MAX CURRENT) information. These LEDs are shown in Figure 14.

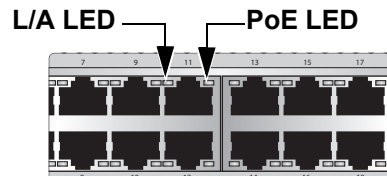

Figure 14. x530-28GPXm and x530-52GPXm Copper Ports LEDs

The states of the x530-28GPXm LEDs are described in Table 14.

Table 14. x530-28GPXm Copper Ports 1 - 24 LED Functions

LED	Ports	State	Description	
L/A	1 - 20	Solid Green	The port has established a 1Gbps link to a network device.	
		Flashing Green	The port is transmitting or receiving data at 1Gbps.	
		Solid Amber	The port has established a 10Mbps or 100Mbps link to a network device.	
		Flashing Amber	The port is transmitting or receiving data at 10Mbps or 100Mbps.	
	21 - 24	Solid Green	The port has established a 1/2.5/5Gbps link to a network device.	
		Flashing Green	The port is transmitting or receiving data at 1/2.5/5Gbps.	
		Solid Amber	The port has established a 100Mbps link to a network device.	
		Flashing Amber	The port is transmitting or receiving data at 100Mbps.	
			Off	Possible causes of this state are: - The port has not established a link with another network device. - The LEDs are turned off. To turn on the LEDs, use the eco-friendly button.

Table 14. x530-28GPXm Copper Ports 1 - 24 LED Functions (Continued)

LED	Ports	State	Description
PoE	1 - 24	Solid Green	PD On - The switch is delivering power to a powered device on the port.
		Solid Amber	PD Error - The switch has shut down PoE on the port because of a fault condition.
		Flashing Amber	PD Max Current - The switch has detected a powered device on the port but is not delivering power to it because doing so would exceed its available power budget.
		Off	<p>No PD - This LED state can result from the following conditions:</p> <ul style="list-style-type: none"> <li>- The port is not connected to a powered device or the device is powered off.</li> <li>- The port is disabled in the management software.</li> <li>- PoE is disabled on the port.</li> <li>- The LEDs are turned off. To turn on the LEDs, use the eco-friendly button.</li> </ul>

The states of the x530-52GPXm LEDs are described in Table 15.

Table 15. x530-52GPXm Copper Ports 1 - 48 LED Functions

LED	Ports	State	Description	
L/A	1 - 40	Solid Green	The port has established a 1Gbps link to a network device.	
		Flashing Green	The port is transmitting or receiving data at 1Gbps.	
		Solid Amber	The port has established a 10Mbps or 100Mbps link to a network device.	
		Flashing Amber	The port is transmitting or receiving data at 10Mbps or 100Mbps.	
	41 - 48	Solid Green	The port has established a 1/2.5/5Gbps link to a network device.	
		Flashing Green	The port is transmitting or receiving data at 1/2.5/5Gbps.	
		Solid Amber	The port has established a 100Mbps link to a network device.	
		Flashing Amber	The port is transmitting or receiving data at 100Mbps.	
			Off	Possible causes of this state are: <ul style="list-style-type: none"> <li>- The port has not established a link with another network device.</li> <li>- The LEDs are turned off. To turn on the LEDs, use the eco-friendly button.</li> </ul>

Table 15. x530-52GPXm Copper Ports 1 - 48 LED Functions (Continued)

LED	Ports	State	Description
PoE	1 - 48	Solid Green	PD On - The switch is delivering power to a powered device connected to the port.
		Solid Amber	PD Error - The switch has shut down PoE on the port because of a fault condition.
		Flashing Amber	PD Max Current - The switch has detected a powered device on the port but is not delivering power to it because doing so would exceed its available power budget.
		Off	No PD - This LED state can result from the following conditions: <ul style="list-style-type: none"> <li>- The port is not connected to a powered device or the device is powered off.</li> <li>- The port is disabled in the management software.</li> <li>- PoE is disabled on the port.</li> <li>- The LEDs are turned off. To turn on the LEDs, use the eco-friendly button.</li> </ul>

**LEDs for the SFP Ports**

The LEDs for the SFP slots on the x530-28GSX Switch are located between the ports, as shown in Figure 15. Each SFP port has one LED. The left LED is for the top port, and the right LED is for the bottom port.

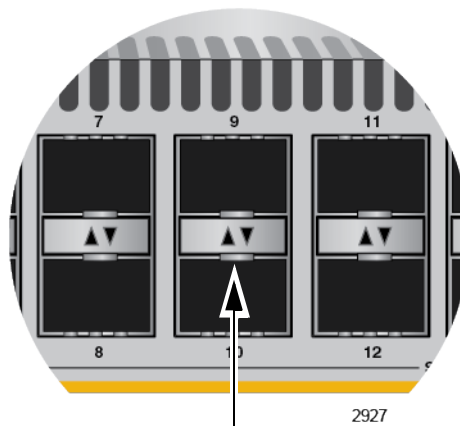

**SFP Port LEDs**

Figure 15. SFP Port LEDs on the x530-28GSX Switch

The states of the x530-28GSX LEDs are described in Table 16.

Table 16. x530-28GSX SFP Network / Stacking LEDs

LED	Ports	State	Description
L/A	1 - 24 SFP LED	Solid Green	The port has established at 1Gbps link to a network device.
		Flashing Green	The port is transmitting or receiving data at 1Gbps.
		Solid Amber	The port has established a 100Mbps link to a network device.
		Flashing Amber	The port is transmitting or receiving data at 100Mbps.
	25-28 SFP+ LED	Solid Green	The port has established a 10Gbps link to a network device.
		Flashing Green	The port is transmitting or receiving data at 10Gbps.
		Solid Amber	The port has established at 1Gbps or link to a network device.
		Flashing Amber	The port is transmitting or receiving data at 1Gbps.
		Off	Possible causes of this state are: - The port has not established a link with another network device. - The LEDs are turned off. To turn on the LEDs, use the eco-friendly button.

**S1 and S2 SFP+ Port LEDs**

SFP+ ports S1 and S2 on the front panels of the switches can be used either as regular Ethernet networking ports or as the trunk in a stack of up to four or eight switches with the VCStack feature. The switches of a VCStack act as a single virtual unit, synchronizing their actions so that switching operations, like spanning tree protocols, virtual LANs, and static port trunks, span across all of the units and ports. For more information, refer to Chapter 2, “Virtual Chassis Stacking” on page 59.

Here are the S1 and S2 ports on the switches:

- ❑ x530-10GHXm switch - ports 9/S1 - 10/S2
- ❑ x530-18GHXm switch - ports 17/S1 - 18/S2
- ❑ x530-28GPXm, x530-28GTXm, and x530-28GSX switches - ports 27/S1 to 28/S2
- ❑ x530-52GPXm and x530-52GTXm switches - ports 51/S1 to 52/S2

See “SFP/SFP+ Transceiver Ports” on page 23 for a description and guidelines of the SFP+ transceivers.

---

**Note**

SFP or SFP+ transceivers must be purchased separately. For a list of supported transceivers, refer to the product data sheet on the Allied Telesis web site.

---

Each transceiver port has one LED. The LEDs are located between the ports. Refer to Figure 16.

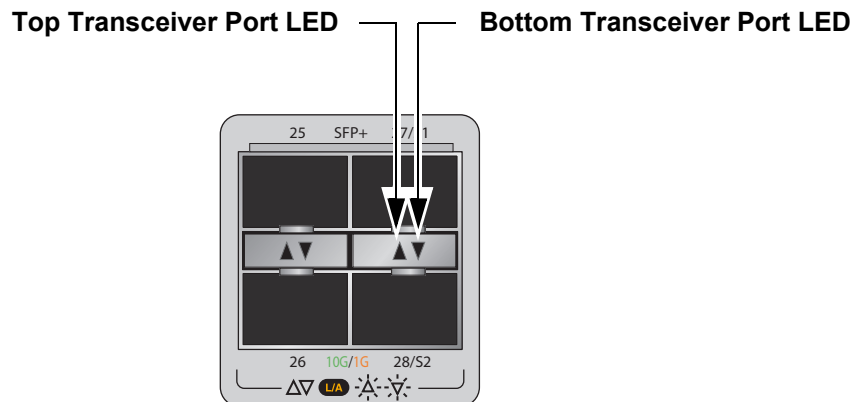

Figure 16. Link and Activity LEDs for the 1Gbps/10Gbps SFP+ Ports

The LEDs display link status and activity. The possible LED states are described in Table 17.

Table 17. Link and Activity Status LEDs for the 1Gbps and 10Gbps Ports

State	Description
Solid Green	The transceiver has established a 10Gbps link to a network device.
Flashing Green	The transceiver is transmitting or receiving data in 10Gbps.
Solid Amber	The transceiver has established a 1Gbps link to a network device.
Flashing Amber	The transceiver is transmitting or receiving data in 1Gbps.
Off	Possible causes of this state are: <ul style="list-style-type: none"> <li>- The port is empty.</li> <li>- The transceiver has not established a link to a network device.</li> <li>- A non-supported module is installed.</li> <li>- The LEDs are turned off. To turn on the LEDs, use the eco-friendly button.</li> </ul>

### Switch ID LED

The switch ID LED, shown in Figure 17, displays the ID number of the switch. A standalone switch has the ID number 0. Switches in a VCStack have the numbers 1 to 8.

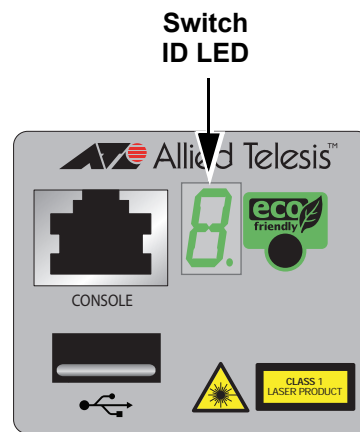

4567

Figure 17. Switch ID LED



The states of the LED when the switch is not operating in the low power mode are shown in Figure 18.

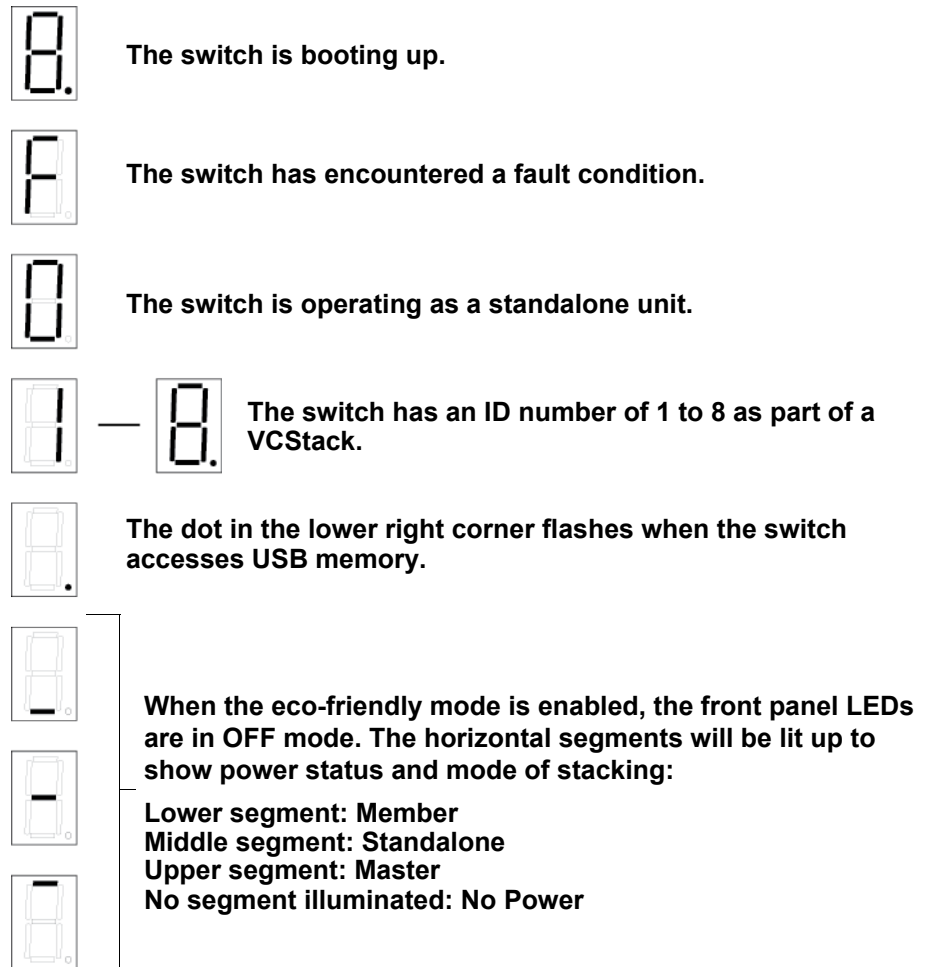

Figure 18. Switch ID LED Description

The switch displays the letter “F” for fault on the ID LED if it detects one of the following problems:

- A cooling fan has failed.
- The input voltage on one or both of the power supplies is outside the normal operating range.
- The internal temperature of the switch has exceeded the normal operating range and the switch may shut down.

---

**Note**

You can use the Simple Network Management Protocol (SNMP) or the SHOW SYSTEM ENVIRONMENT command in the command line interface to identify the source of the problem.

---

## VCStack Feature

---

You can use the switches as standalone units or join up to eight units with the VCStack feature. The switches of a VCStack act as a single virtual unit. They synchronize their actions so that switching operations (such as spanning tree protocols, virtual LANs, and static port trunks) span across all of the units and ports. Two advantages of stacks are:

- ❑ You can manage multiple units simultaneously, which can simplify network management.
- ❑ You can add redundancy to your network topology by distributing functions across multiple switches. For instance, a static port trunk on a standalone switch can consist of ports from the same switch. In contrast, a static trunk on a stack can have ports from different switches in the same stack.

---

### **Note**

This guide explains how to install switches as a stack with Virtual Chassis Stacking (VCStack™). For instructions on how to install the devices as standalone switches, refer to the *x530 Series Installation Guide for Standalone Switches*.

---

## USB Port

---

The USB port on the management panel is used for the following functions:

- Store configuration files on flash drives.
- Restore configuration files to switches that have lost or corrupted settings.
- Configure replacement units by downloading configuration files from a flash drive.
- Update the management firmware.

The port is USB 2.0-compatible.

## Console Port

---

The Console port is an RS232 serial management port. You use the port to access the AlliedWare Plus management software on the switch to configure the feature settings or monitor status or statistics. This type of management is commonly referred to as local management because you have to be at the physical location of the switch and use the management cable included with the unit. The switch does not have to have an IP address for local management.

To establish a local management session with the switch, use the provided management cable to connect a terminal or a computer with a terminal emulation program to the Console port, which has an RJ-45 style (8P8C) connector. The cable has RJ-45 style (8P8C) and DB-9 (D-sub 9-pin) connectors.

The Console port has the following settings:

- Default baud rate: 9,600 bps (range is 9,600 to 115,200 bps)
- Data bits: 8
- Parity: None
- Stop bits: 1
- Flow control: None

---

**Note**

These settings are for a DEC VT100 or ANSI terminal, or an equivalent terminal emulation program.

---

## Power Supplies

---

The x530 Series switches come with dual pre-installed AC power supplies. Refer to “Power Specifications” on page 195 for the input voltage ranges.



---

**Warning**

The power cord is used as a disconnection device. To de-energize equipment, disconnect the power cord. ⚡ E3

---

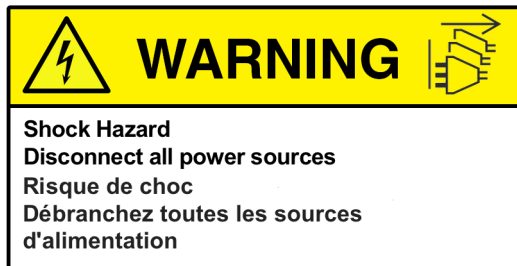

---

**Note**

Power supplies are not field-replaceable.

---

## Software and Hardware Releases

---

Software and hardware releases for the AlliedWare Plus operating software and x530 Series switches are listed in Table 18.

Table 18. Software and Hardware Releases

Software Version	Hardware	VCStack
v5.4.8-2	x530-28GPXm switch x530-28GTXm switch	Allows stacks of up to eight switches using the SFP/SFP+ transceiver ports for the stack trunk.
v5.4.9-2	Adds the following switches: x530-52GPXm switch x530-52GTXm switch	Allows stacks of up to eight switches using the SFP/SFP+ transceiver ports or the 1/2.5/5Gbps ports for the stack trunk.
v5.5.1-0.2	Adds the following switches: x530-10GHXm switch x530-18GHXm switch	Allows stacks of up to eight switches using the SFP/SFP+ transceiver ports or the 1/2.5/5Gbps ports for the stack trunk.
v5.5.2-2	Adds the following switch: x530-28GSX switch	Allows stacks of up to eight switches (or up to four switches if using 1Gbps for stacking).

## Chapter 2

# Virtual Chassis Stacking

---

The following sections are discussed in this chapter:

- ❑ “Overview” on page 60
- ❑ “Stacking Guidelines” on page 61
- ❑ “Stack Trunks” on page 63
- ❑ “Stack Trunks of the Default 10Gbps SFP+ S1 and S2 Stacking Ports” on page 64
- ❑ “Stack Trunks of 5Gbps Copper Ports” on page 69
- ❑ “Stack Trunks of 1Gbps Copper Ports” on page 72
- ❑ “Stack Trunks of 1Gbps SFP Ports 1 to 24 on x530-28GSX Switches” on page 74
- ❑ “Invalid Stack Trunks” on page 76
- ❑ “Master and Member Switches” on page 78
- ❑ “Switch ID Numbers” on page 80
- ❑ “Optional Feature Licenses” on page 81
- ❑ “Mixed Switch Stacks” on page 82
- ❑ “Planning the Stack” on page 85
- ❑ “Configuring Mixed-Mode VCStacking” on page 86
- ❑ “Stacking Worksheet” on page 87

---

### Note

For more information on VCStack, refer to the *Stacking Introduction and Stacking Commands* chapters in the *Command Reference: x530 Series Switches Running AlliedWare Plus Version 5.5.0* at [www.alliedtelesis.com/library](http://www.alliedtelesis.com/library).

---

## Overview

---

The VCStack feature is used to connect multiple x530 Series switches into a single, virtual networking unit. Some of the benefits of the VCStack feature are listed here:

- ❑ Simplifies management - You can manage the devices of the stack as a single unit, rather than individually. Your local and remote management sessions give you management access to all the switches in the stack.
- ❑ Reduces IP addresses - A stack requires only one IP address for remote management access, thereby reducing the number of IP addresses you have to assign to network devices.
- ❑ Adds redundancy to your network topology by distributing functions across multiple switches. For example, you can create port aggregators of ports from different switches in a stack, rather than from only one switch. Distributing the ports of an aggregator across two or more switches in a stack increases its resiliency because it can continue to function, though at a reduced bandwidth, even if one of the switches stops functioning.
- ❑ Reduces protocol requirements - Building a stack might eliminate the need to configure some protocols, such as the Virtual Router Redundancy Protocol or Spanning Tree Protocol.



## Stacking Guidelines

---

This section lists the general guidelines to building a VCStack of x530 Series switches. Stacking guidelines differ depending on the version of the AlliedWare Plus management software on the switches. (Instructions in Chapter 7, “Building the Trunk with the Default SFP+ S1 and S2 10Gbps Stacking Ports” on page 131 and Chapter 8, “Building the Stack with Gigabit or 5G Multi-speed Ports” on page 149 explain how to display the version numbers of the management software.)

- ❑ You must connect the switches of a stack together with a trunk, consisting of a minimum of two ports per switch.
- ❑ Here are the ports that you can use as trunk ports on x530 Series switches:
  - SFP+ ports with 10Gbps transceivers or direct connect cables
  - SFP+ ports with 1Gbps transceivers
  - 5Gbps multi-speed ports
  - 1Gbps copper ports
  - 1Gbps SFP ports 1 to 24 on the x530-28GSX Switch
- ❑ Here are the maximum numbers of x530 Series switches that you can have in stacks:
  - Maximum eight switches with trunks of SFP+ ports with 10Gbps transceivers or direct connect cables
  - Maximum four switches with trunks of SFP+ ports with 1Gbps transceivers
  - Maximum eight switches with trunks of 5Gbps multi-speed ports
  - Maximum four switches with trunks of 1Gbps copper ports
  - Maximum four switches with trunks of 1Gbps SFP ports 1 to 24 on the x530-28GSX Switch
- ❑ The maximum number of trunk ports per switch varies depending on the port type:
  - Maximum four ports per switch for trunks of SFP+ ports with 10Gbps transceivers or direct connect cables
  - Maximum four ports per switch for trunks of SFP+ ports with 1Gbps transceivers
  - Maximum four ports per switch for trunks of 5Gbps Multi-speed ports

- Maximum eight ports per switch for trunks of 1Gbps copper ports
- Maximum eight ports per switch for trunks of 1Gbps SFP ports 1 to 24 on the x530-28GSX Switch
- ❑ The default trunk ports on the x530 Series switches are the last two SFP+ ports:
  - Ports 9/S1 and 10/S2 on the x530-10GHXm Switch
  - Ports 17/S1 and 18/S2 on the x530-18GHXm Switch
  - Ports 27/S1 and 28/S2 on the x530-28GTXm, x530-28GPXm, and x530-28GSX Switches
  - Ports 51/S1 and 52/S2 on the x530-52GTXm and x530-52GPXm Switches
- ❑ Stacking is enabled by default on x530 Series switches.
- ❑ No additional software or licenses are required for stacking within the x530 Series switches.
- ❑ Stacks can have x530, x530DP, and x530L Switches. However, this type of stack, referred to as a mixed stack, requires a license and additional configuration steps. Refer to “Mixed Switch Stacks” on page 82.
- ❑ A stack of x530 Series switches cannot contain other stacking switches, such as x600 or x610 Series switches.
- ❑ The links of a stack trunk must be direct connections between switches. You cannot install a networking device, such as a media converter or Ethernet switch, between two stacking ports.
- ❑ SFP+ transceivers and direct attach cables used for a stack trunk must be from Allied Telesis. Switches will not form a stack with transceivers from other network equipment providers. For a list of supported transceivers, refer to the product data sheet on the Allied Telesis web site.
- ❑ To build a trunk of 1Gbps copper ports on 52-port x530-52GPXm and x530-52GTXm Switches, you may select a maximum of eight ports in the port range 1 to 20. The trunk ports do not have to be consecutive.
- ❑ To build a trunk of 5Gbps multi-speed ports on 52-port x530-52GPXm and x530-52GTXm Switches, you may select a maximum of four ports in the port ranges 41 to 44 or 45 to 48. The ports must be consecutive.

## Stack Trunks

---

Stack trunks connect the switches of a stack together. A stack trunk consists of a minimum of two ports on each device. For switches with AlliedWare Plus v5.5.1-1.2 or later, you can choose the ports of the trunk. Your choices are listed in Table 19:

Table 19. Trunk Ports

Switch	SFP+ S1 and S2 Ports (Default)	Additional SFP+ Ports	Copper 5G Multi-speed Ports	Copper 1G Ports	SFP 1G Ports
x530-10GHXm	9/S1, 10/S2	None	1-8 <sup>1</sup>	None	None
x530-18GHXm	17/S1, 18/S2	None	1-16 <sup>1</sup>	None	None
x530-28GPXm	27/S1, 28/S2	25, 26	21-24 <sup>2</sup>	1-20	None
x530-28GTXm	27/S1, 28/S2	25, 26	21-24 <sup>3</sup>	1-20	None
x530-28GSX	27/S1, 28/S2	25, 26	None	None	1-24
x530-52GPXm	51/S1, 52/S2	49, 50	41-48 <sup>2</sup>	1-40	None
x530-52GTXm	51/S1, 52/S2	49, 50	41-48 <sup>3</sup>	1-40	None

1. PoE++ copper ports.
2. PoE+ copper ports.
3. Non-PoE+ copper ports.

The guidelines are discussed in the following sections:

- “Stack Trunks of the Default 10Gbps SFP+ S1 and S2 Stacking Ports” on page 64
- “Stack Trunks of 5Gbps Copper Ports” on page 69
- “Stack Trunks of 1Gbps Copper Ports” on page 72
- “Stack Trunks of 1Gbps SFP Ports 1 to 24 on x530-28GSX Switches” on page 74

---

### Note

The following discussions apply to AlliedWare Plus v5.5.1-1.2 or later. Earlier versions of the operating system have different trunk rules and restrictions.

---

## **Stack Trunks of the Default 10Gbps SFP+ S1 and S2 Stacking Ports**

---

You can build stack trunks with 10Gbps SFP+ transceiver ports on the switches. The guidelines are described here:

- ❑ Stacks with AlliedWare Plus v5.4.8-2 or earlier can have up to four switches.
- ❑ Stacks with AlliedWare Plus v5.4.9-2 or later can have up to eight switches.
- ❑ Trunks must have a minimum of two ports per switch.
- ❑ Here are the default 10Gbps SFP+ trunk ports.
  - x530-10GHXm ports 9/S1 and 10/S2
  - x530-18GHXm ports 17/S1 and 18/S2
  - x530-28GTXm, x530-28GPXm, and x530-28GSX ports 27/S1 and 28/S2
  - x530-52GTXm and x530-52GPXm ports 51/S1 and 52/S2
- ❑ SFP+ transceivers must be from Allied Telesis and be approved for use in the product. For a list of supported 10Gbps SFP+ transceivers, refer to the product data sheet on the Allied Telesis web site.

---

### **Note**

Transceivers are purchased separately.

---

- ❑ You can use the default 10Gbps stacking ports as regular networking ports by disabling the stacking feature or by using other ports as the trunk ports.
- ❑ A stack trunk can have fiber optic and SP10TW direct connect cables in the same stack. See Figure 21 on page 68.

Figure 19 shows examples of stack trunks for two, three and four switches, using the x530-28GTXm default stacking ports S1 and S2.

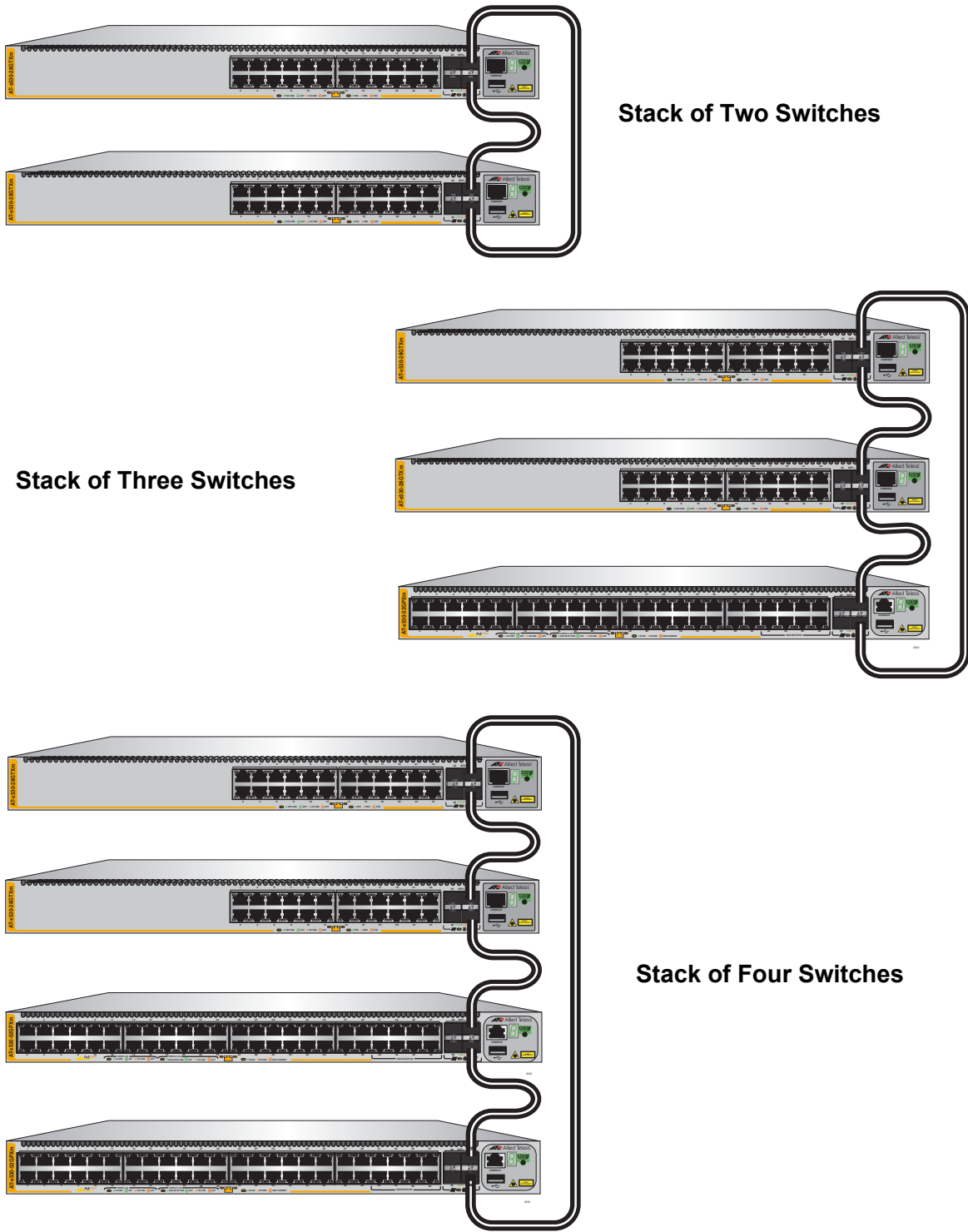

Figure 19. Stack Trunks of Default S1 and S2 Ports

In stacks of three or more switches the amount of inter-switch network traffic might require a stacking trunk with greater bandwidth than that provided by the default ports of:

- ❑ x530-28GTXm, x530-28GSX, and x530-28GPXm ports 27/S1 and 28/S2
- ❑ x530-52GTXm and x530-52GPXm ports 51/S1 and 52/S2

For such situations additional SFP+ ports can be used:

- ❑ x530-28GTXm and x530-28GPXm, and x530-28GSX ports 25 and 26
- ❑ x530-52GTXm and x530-52GPXm ports 49 and 50

---

**Note**

x530-10GHXm and x530-18GHXm do not have additional SFP+ ports

---

Figure 20 shows examples of stacks of three and four switches using all four SFP+ ports for the stack trunk.

**Stack of Three Switches**

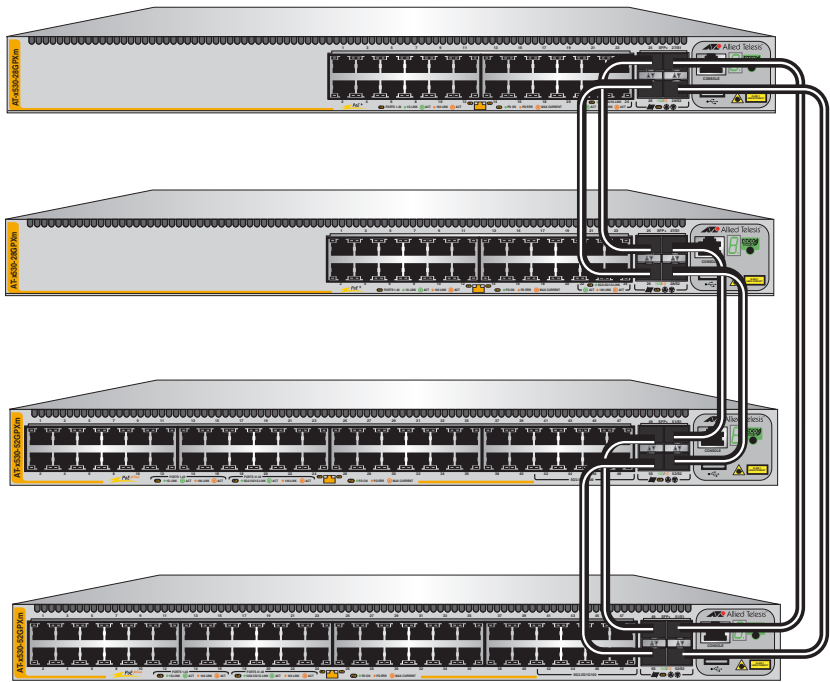
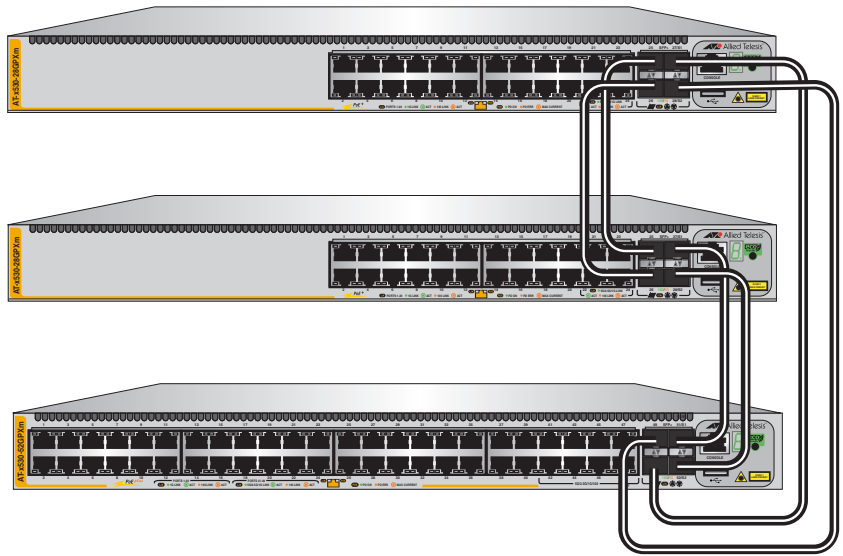

**Stack of Four Switches**

4630

Figure 20. Stack Trunks Using all Four Ports

10Gbps stack trunks can have both fiber optic transceivers and SP10TW direct attach cables. The example in Figure 21 illustrates a stack of four switches located in two separate buildings. SP10TW direct attach cables connect switches that are in the same wiring closet while fiber optic transceivers connect the switches across the buildings.

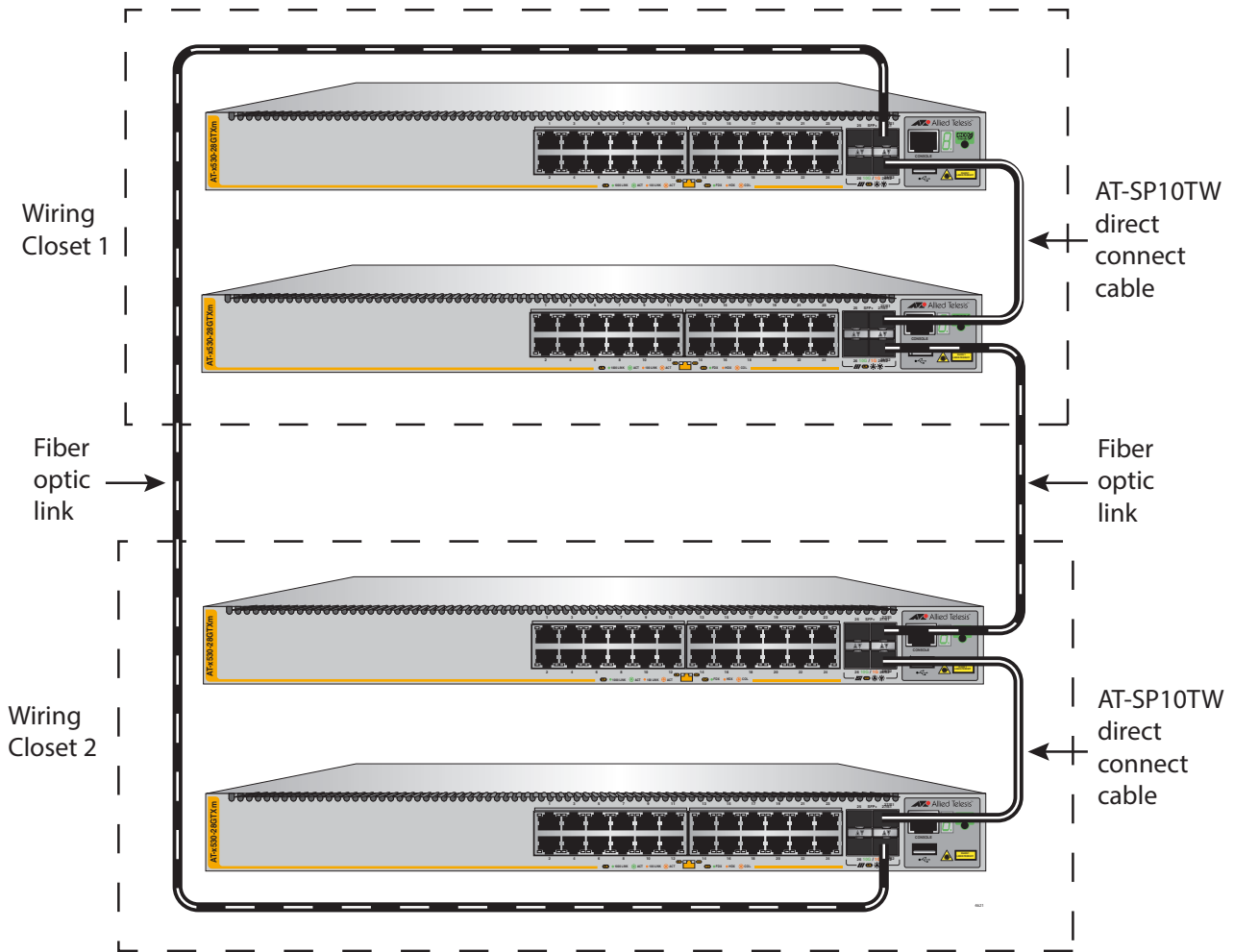

Figure 21. 10Gbps Stack Trunk with Both SFP+ Fiber Optic Transceivers and SP10TW Direct Connect Cables



## Stack Trunks of 5Gbps Copper Ports

---

The 10Gbps SFP+ ports S1 and S2 are not the only ports you can use for a trunk of a stack. If you prefer to use the 10Gbps SFP+ ports for other functions you can use the 5Gbps Multi-speed copper ports for the trunk instead. You can use up to eight 5Gbps Multi-speed ports per switch for the trunk. As with a trunk based on 10Gbps SFP+ ports, the more 5Gbps Multi-speed ports a trunk has, the greater its bandwidth.

Here are the guidelines:

- ❑ Requires AlliedWare Plus v5.5.1-1.2 or later.
- ❑ Stacks can have up to eight switches.
- ❑ Here are the Multi-speed ports.
  - x530-10GHXm: 1 to 8
  - x530-18GHXm: 1 to 16
  - x530-28GTXm: 21 to 24
  - x530-28GPXm: 21 to 24
  - x530-52GTXm: 41 to 48
  - x530-52GPXm: 41 to 48
- ❑ You designate the stack ports with the STACKPORT command.
- ❑ Once ports are designated as trunk ports, you cannot view or change their parameter settings.
- ❑ The ports have to stay at the default configurations.

A stack trunk of 5Gbps Multi-speed ports for two switches can have from two to eight links per switch. As mentioned previously, the more links in a trunk, the greater its bandwidth and resiliency. Examples are shown in Figure 22.

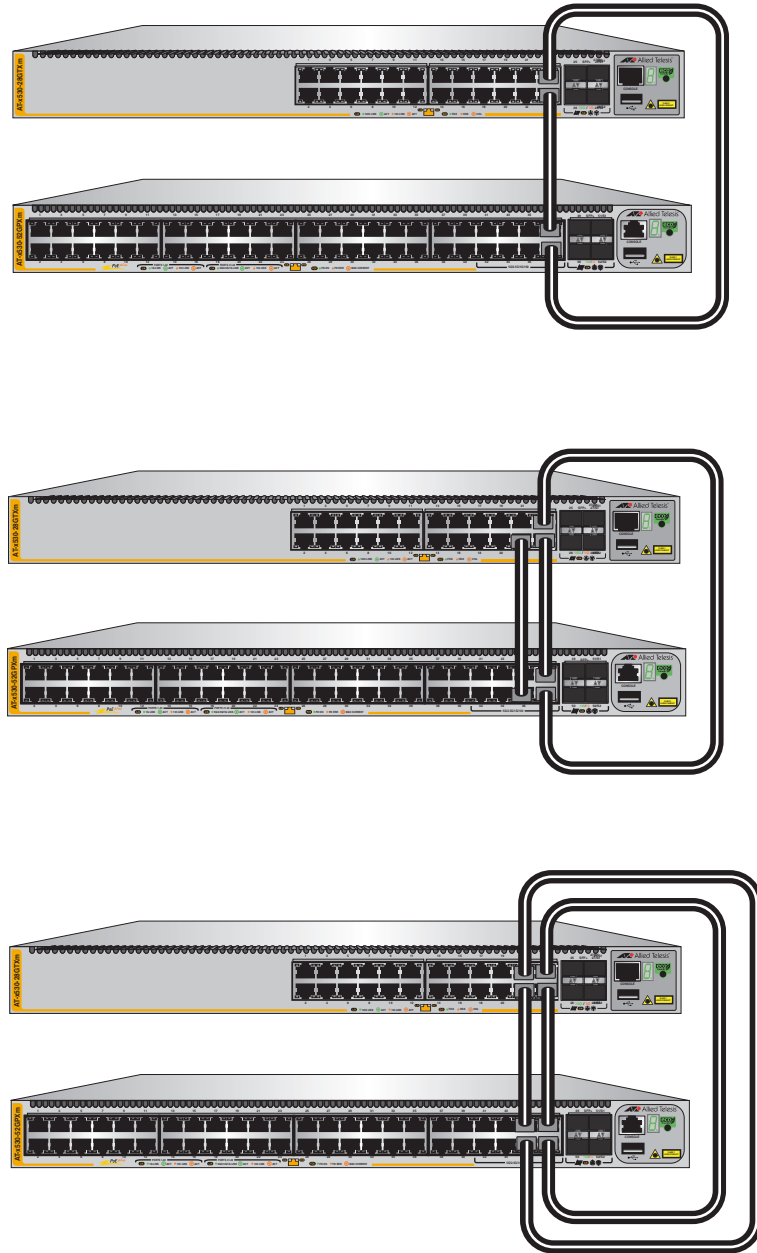

Figure 22. Trunks of 5Gbps Multi-speed Ports for Stacks of Two Switches

A trunk of 5Gbps Multi-speed ports for a stack of three or more switches can have two or four ports per switch. Refer to Figure 23.

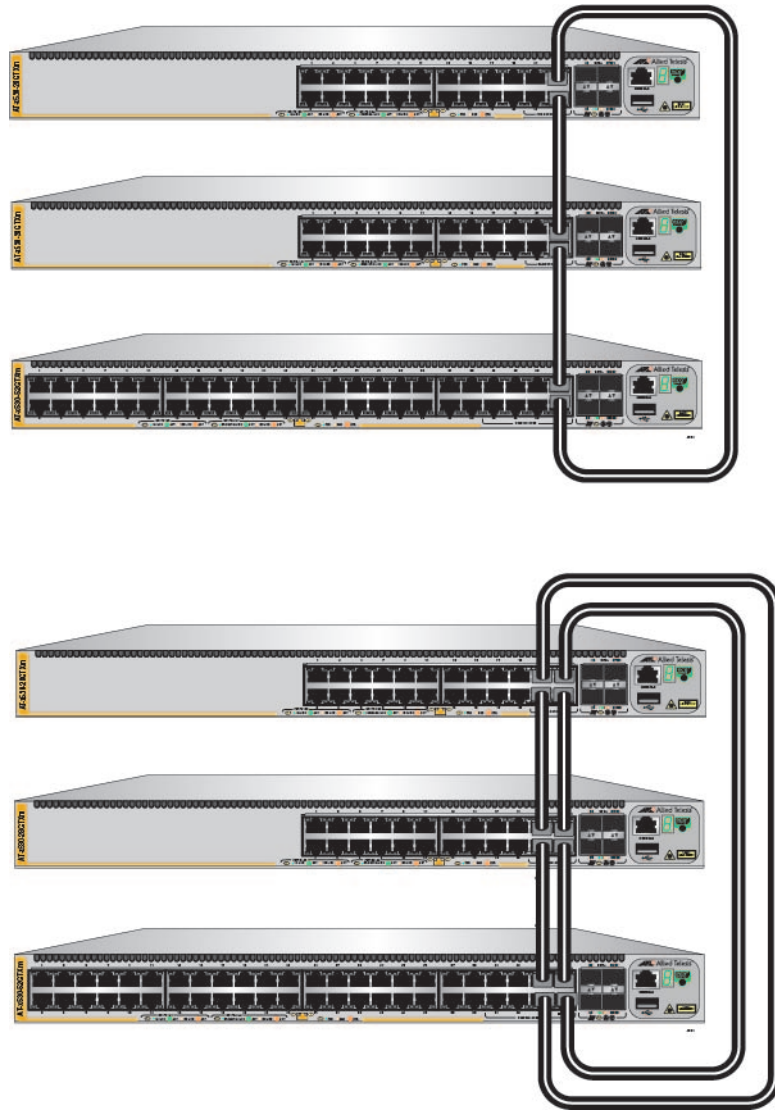

Figure 23. Trunks of 5Gbps Ports for Stacks of Three Switches

## Stack Trunks of 1Gbps Copper Ports

---

The 10Gbps SFP+ ports are not the only ports you can use for a trunk of a stack. If you prefer to use the 10Gbps ports for other functions you can use the 1Gbps copper ports for the trunk instead. You can use from two to eight 1Gbps copper ports per switch for the trunk. As with a trunk based on 10Gbps SFP+ ports, the more ports a trunk has, the greater its bandwidth.

Here are the guidelines for trunks of 1Gbps copper ports:

- ❑ Stacks can have up to four x530 Switches.
- ❑ Trunks can have up to eight copper ports per switch.
- ❑ Switches must have the same number of trunk ports.
- ❑ The stack will be easier to manage if you use the same 1Gbps copper ports as the trunk on all the switches.
- ❑ Stacks with trunks of 1Gbps copper ports cannot contain x530-28GSX Switches because they do not have copper ports. To build stacks of x530-28GSX Switches with other x530 models, use SFP+ ports for the trunk instead.
- ❑ Trunk ports are designated with the STACKPORT command.
- ❑ Once ports are designated as trunk ports, you cannot view or change their parameter settings.

Figure 24 illustrates stacks of two, three, and four switches with four trunk ports of 1Gbps copper per switch. (The maximum is eight trunk ports per switch.)

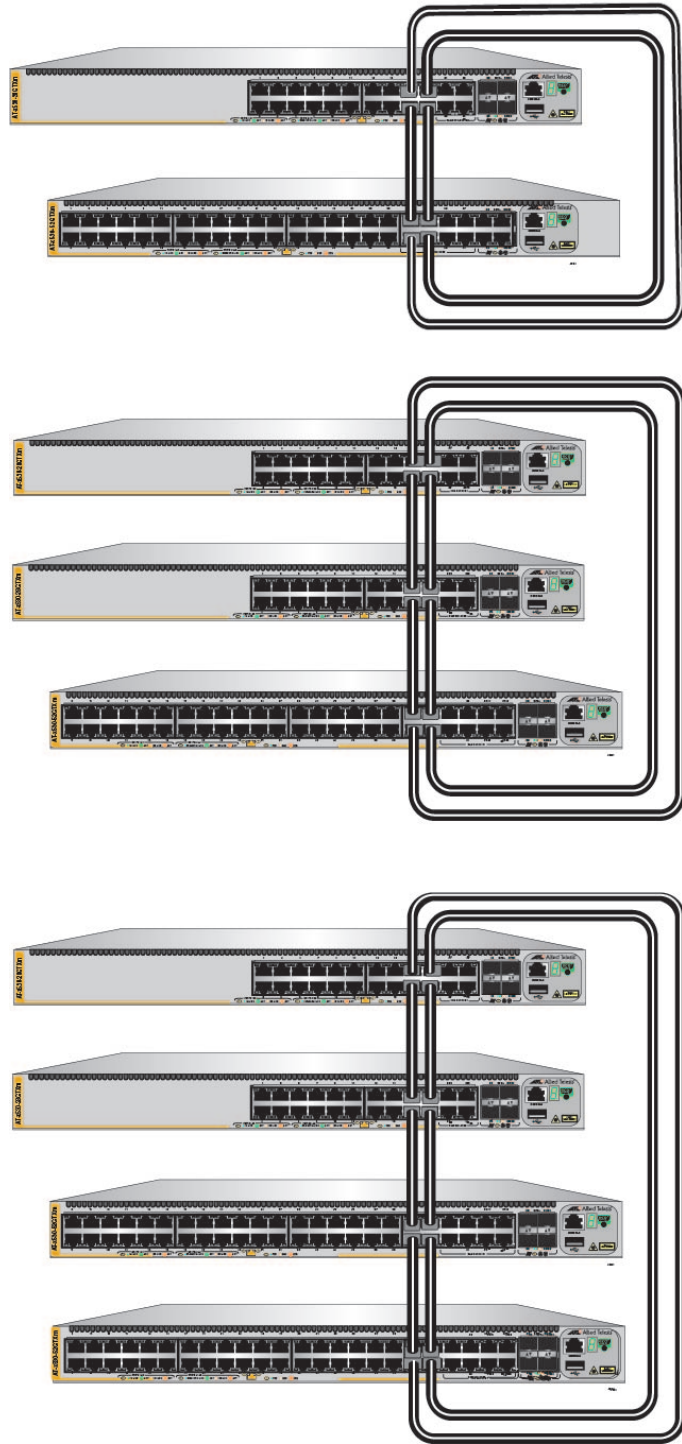

Figure 24. Stack Trunks of 1Gbps Copper Ports

## **Stack Trunks of 1Gbps SFP Ports 1 to 24 on x530-28GSX Switches**

---

Unlike the other switches in the x530 Series, the x530-28GSX Switch does not have any 1Gbps copper ports or 5Gbps multi-speed copper ports. Instead, it has four SFP+ ports and twenty four 1Gbps SFP ports. To build a stack of x530-28GSX Switches, you can use either the SFP+ ports or up to eight of the 1Gbps SFP ports. For guidelines on building a trunk with SFP+ ports, refer to “Stack Trunks of the Default 10Gbps SFP+ S1 and S2 Stacking Ports,” on page 66. Here are the guidelines to building the trunk on x530-28GSX Switches with 1Gbps SFP ports:

- ❑ Stacks can have up to four x530-28GSX Switches.
- ❑ Trunks can have from two to eight 1Gbps SFP ports per switch.
- ❑ Switches must have the same number of trunk ports.
- ❑ Stacks can have only x530-28GSX Switches. To build stacks that have x530-28GSX Switches and other x530 models, use SFP+ ports for the trunk instead.
- ❑ The stack will be easier to manage if you use the same 1Gbps SFP ports as the trunk on all the switches.
- ❑ Once ports are designated as trunk ports with the STACKPORT command, you cannot view or change their settings

The example in Figure 25 shows two stacks of three x530-28GSX Switches with trunks of 1Gbps SFP ports. The switches are connected by two ports each in the first example and four ports in the second example, for greater bandwidth. The maximum number of ports per switch for the trunk is eight.

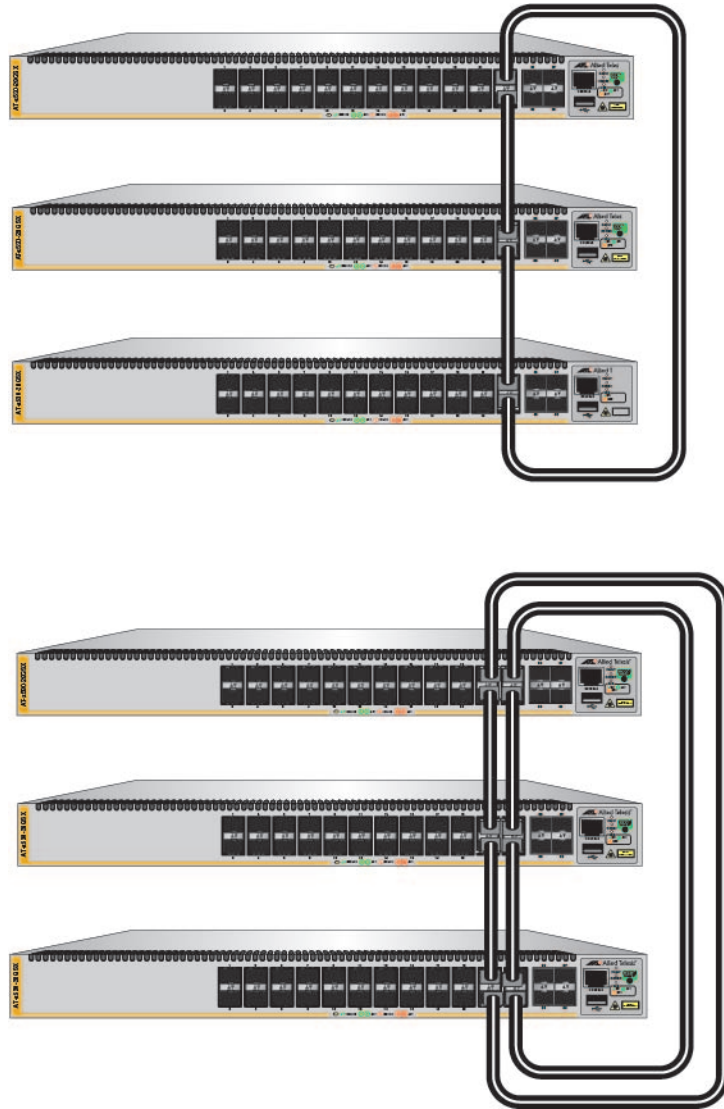

Figure 25. Trunks of 1Gbps SFP Copper Ports for Stacks of Three x530-28GSX Switches

## Invalid Stack Trunks

Figure 26 through Figure 29 on page 77 show examples of different types of invalid stack trunks.

**Example 1** Stack trunks must be direct links between trunk ports. There cannot be any intermediate networking devices, such as media converters, Ethernet switches, or routers, between trunk ports. Figure 26 is an example of this type of invalid trunk.

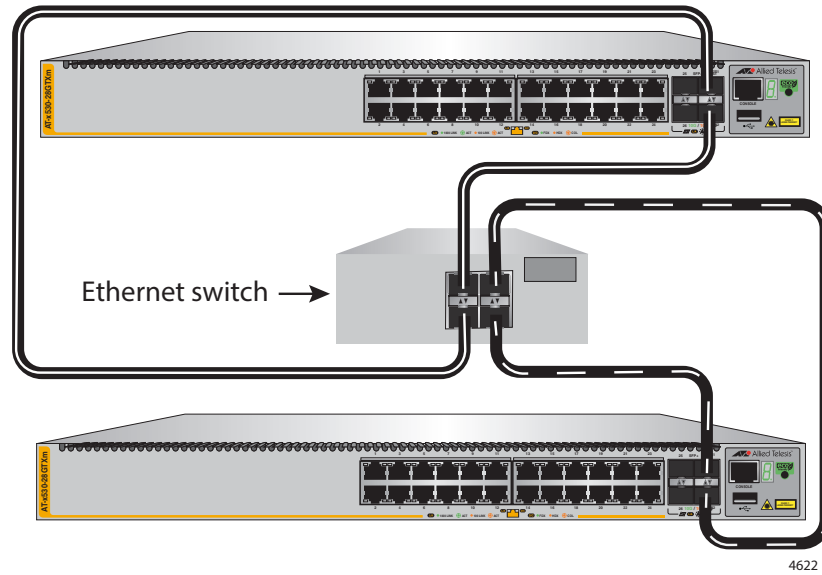

Figure 26. Invalid Stack Trunk with an Intermediary Networking Device

**Example 2** Trunks must have a minimum of two ports used per switch. Figure 27 is an example of an invalid stack trunk with one port used per switch.

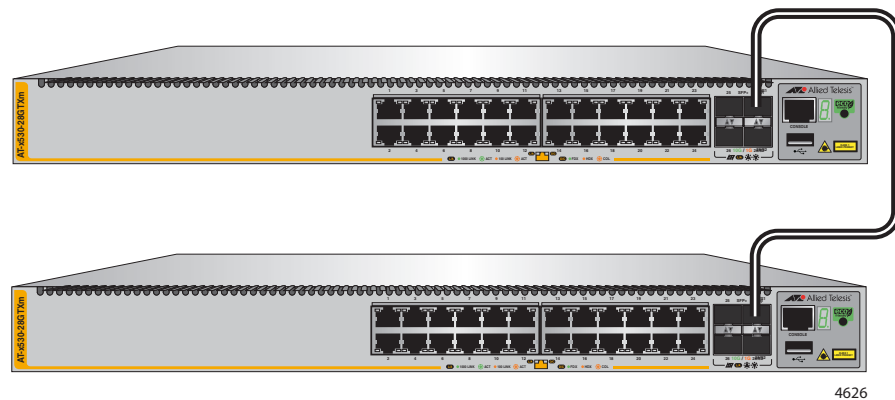

Figure 27. Invalid Stack Trunk with One Port Used Per Switch



**Example 3** Trunks must have the same number of physical links between switches. Figure 28 is invalid because the top and middle switches are connected with two links while the top and middle switches are connected to the bottom switch with only one link each.

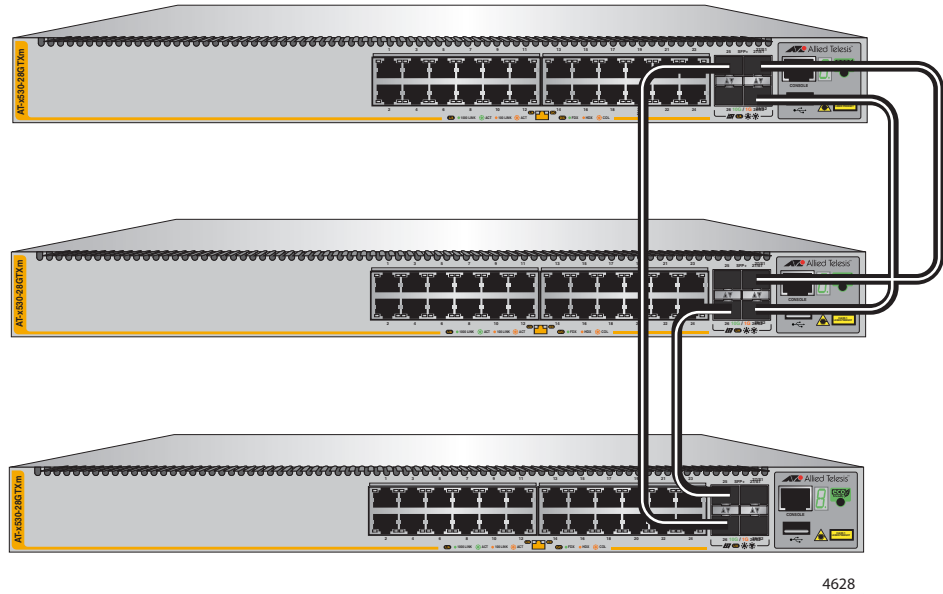

Figure 28. Invalid Stack Trunk with Different Numbers of Links

**Example 4** Trunk ports of a stack must all be the same type. The trunk in Figure 29 is invalid because it has both 10Gbps SFP+ and 5Gbps multi-speed ports.

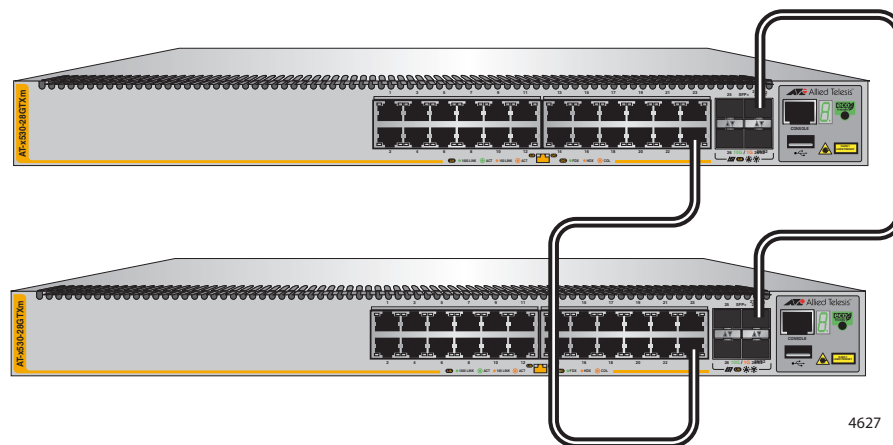

Figure 29. Invalid Stack Trunk with Different Port Types

## Master and Member Switches

---

A stack has one master switch. The other switches are member switches. The main functions of the master switch are listed here:

- ❑ Coordinate and monitor stack operations.
- ❑ Configure the parameter settings of the switches using its configuration file in flash memory, whenever the stack is reset or powered on.
- ❑ Verify that the switches are using the same version of management software. It automatically downloads its management software to the member switch over the stacking cables if the member switch has a different version of the management software.
- ❑ Verify that the switches have different ID numbers. It automatically assigns new ID numbers to resolve situations where two or more switches have the same ID number.
- ❑ Verify that the stacking transceivers are from Allied Telesis and they are cabled correctly.

The parameter settings of the switches of the stack are stored in configuration files in the flash memories of the master and member switches. Each file contains all the settings for the switches in the stack. The switches update the files with the latest parameter settings whenever you issue the `WRITE` command to save your changes.

When you reset or power on the stack, the master switch uses the configuration file in its flash memory to restore its own parameter settings as well as the parameter settings of the member switches in the stack. A member switch uses its configuration file to restore parameter settings only if the master switch is removed or fails, and it becomes the new master switch of the stack.

### Selection of the Master Switch

The switches of a stack select the master switch during the initialization process, which they perform whenever they are powered on or reset. The master switch is selected using the following parameters:

- ❑ Stack priority numbers
- ❑ MAC addresses

The stack priority number is an adjustable value of 0 to 255. The lower the number, the higher the priority. The switch with the lowest priority number (highest priority) becomes the master switch of a stack. The default priority value is 128.

When switches have the same priority values, they compare their MAC addresses to select the master switch. As with the priority value, the lower the MAC address, the higher the priority. The switch with the lowest MAC address becomes the master switch.

If you power on the stack for the first time without adjusting the priority values, the master switch is selected based on the MAC addresses if the units are powered on simultaneously. If you power on the switches one at a time, the master switch is the first switch to be powered on.

You can set the priority values of the switches either before or after you build the stack. Changing the values after the stack is operating does not change the parameter settings of the stack or the ID numbers of the devices.

It should be noted that the master switch of a stack does not have to have the ID number 1. It can have any ID number.

## Switch ID Numbers

---

Each switch in a stack must have a unique ID number. The possible ID numbers depend on the version number of the AlliedWare Plus management software. The ID numbers are 1 to 8 for the eight switches in a stack with AlliedWare Plus v5.5.1. The default is 1.

The ID numbers are displayed on the ID LEDs on the front panels of the units. You can assign the numbers yourself or let the master switch assign the numbers automatically when you initially power on the stack.

Use the ID numbers to identify the individual switches and ports when configuring the devices with the commands in the management software.

The ID numbers are also used to identify the parameter settings of the switches in the configuration files. When the stack is reset or power cycled, the master switch uses the ID numbers to identify the devices to which the parameter settings belong.



### Caution

Do not change the ID numbers of the switches after configuring the parameter settings of the stack. Otherwise, the parameter settings might be applied to the wrong devices when you reset or power cycle the stack. *ES* E79

---

The switches do not use the ID numbers to select the master switch. The selection of the master switch is based on their priority numbers and MAC addresses, as explained in “Selection of the Master Switch” on page 78.

## Optional Feature Licenses

---

The x530 Series switches come with the AlliedWare Plus operating system and a base set of features that are available as soon as you install the devices. Allied Telesis offers additional features and capabilities for the switches. They come with the AlliedWare Plus operating system, but have to be unlocked before you can use them. Unlocking optional features requires licenses from Allied Telesis. For a list of optional feature licenses for the product, refer to its product sheet on the Allied Telesis web site.

Here are the guidelines to feature licenses for a stack of x530 Series switches:

- ❑ The VCStack feature is part of the base features of the switch. It does not require an additional feature license.
- ❑ You can install feature licenses while the switches are operating as standalone units or a stack.
- ❑ When ordering feature licenses for the switches of a stack, you must order one license for each switch.
- ❑ The switches will form a stack even if they have different feature licenses. However, the additional features are only available on those switches that have the necessary licenses. The stack generates a warning message if it detects that the switches do not have the same feature licenses. To resolve the issue, you can use the REMOTE-LOGIN command to log onto the individual switches in a stack to install new licenses. For more information, refer to the *Command Reference: x530 Series Switches Running AlliedWare Plus Version 5.5.0* at [www.alliedtelesis.com/library](http://www.alliedtelesis.com/library).

## Mixed Switch Stacks

---

The x530 family consists of the following series of Gigabit Ethernet switches:

- ❑ x530L
- ❑ x530
- ❑ x530DP

If you have previously worked with other Allied Telesis products that support stacking, than you may already know that the feature is typically not supported across switches from different series. This means that all the switches of a stack usually have to be from the same series.

However, the x530 family of switches does permit stacks of switches from different x530 series. For instance, you might build stacks of both x530 and x530DP switches, or models from all three series.

Building mixed stacks that have x530L and one or more of the x530 or x530DP switches require a special license and several additional configuration steps. This is because x530L switches have different base feature sets in their base licenses than the other switches. Stacks, on the other hand, require that all switches have the same feature sets. The following sections explain how to build mixed stacks of x530L and one or more of the other switches.

---

### Note

The following discussions do not apply to mixed stacks of x530 series and x530DP switches. The feature sets in their base licenses are the same. Consequently, building mixed stacks of those switches does not require a special license or additional configurations steps. Additionally, you can build the trunks using SFP+ ports, 5Gbps multi-speed ports, or 1Gbps copper ports.

---

### Stack Mixed-Mode Licenses

One of the first steps to building a mixed stack of x530 or x530DP Switches and one or more x530L Switches is to obtain stack mixed-mode licenses from Allied Telesis and install the licenses on the switches. Switches of mixed stacks need the licenses to form the stacks.

The different switch series have different stack mixed-mode licenses. To receive the correct type and number of licenses, be sure to specify the number of x530L, x530, and x530DP switches when ordering the licenses.

## Stack Mixed-Mode Commands

After installing the stack mixed-mode licenses, you have to enter the STACK MIXED-MODE command in the Global Configuration mode of the AlliedWare Plus operating system. The command designates the switches as part of a mixed stack. When you issue this command on x530 series or x530DP switches, they configure their base feature sets to match the feature set in the base licenses in x530L switches.

## Trunk Ports

An important component of a stack is the trunk. These are the ports that link the switches together. With the x530 and x530DP Switches, you can choose the trunk ports from the SFP+ ports, 5Gbps multi-speed ports, and 1Gbps copper and SFP ports. The x530L Switches, however, do not have 5Gbps multi-speed or 1Gbps SFP ports. Consequently, trunks for x530L

## Optional Licenses

Here are guidelines for optional licenses in mixed stacks of x530L and x530 and/or x530DP switches:

- ❑ Mixed stacks do not support premium licenses. Do not install premium licenses on switches in mixed stacks.
- ❑ Mixed stacks do support the G8032 ring protection and continuous PoE power licenses.
- ❑ All the switches in the stack must have the same optional licenses.

## AlliedWare Plus

Mixed stacks require AlliedWare Plus v5.4.9-0.1 and later.

## Guidelines

Here are the guidelines to building mixed stacks of x530L and x530 or x530DP switches:

- ❑ The trunk ports can be SFP+ ports or 1Gbps copper ports.
- ❑ The switches must have AlliedWare Plus v5.4.9-0.1 or later.
- ❑ You have to install stack mixed-mode licenses on all the switches.
- ❑ You have to perform the STACK MIXED-MODE command on all the switches so that they operate with the same base set of features.
- ❑ If you break-up a mixed stack or remove the x530L switches, perform the NO STACK MIXED-MODE command on the x530 and x530DP switches to restore their full feature sets.
- ❑ If you break-up a mixed stack or remove the x530L switches, you can leave the stack mixed-mode licenses on the switches. They will not interfere with switch operations.
- ❑ The STACK MIXED-MODE and NO STACK MIXED-MODE commands require rebooting the switch.
- ❑ Mixed stacks do not support premium licenses.
- ❑ Mixed stacks do support the G8032 ring protection and continuous PoE power licenses.

- ❑ If optional licenses are installed on the switches, all the units must have the same licenses. Switches that have different feature licenses might still be able to form the stack, but the feature inconsistencies are logged and appear in the show license output.
- ❑ A mixed stack generates the following log message if the STACK MIXED-MODE command was not performed on all the switches:

```
16:22:21 awplus vcs[1631]: Member 1 cannot join the
stack because of stack mixed mode incompatibility.
Enable 'stack mixed-mode'.
```

- ❑ The trunk for a mixed stack can have a minimum of two ports and a maximum of eight ports per switch.
- ❑ Trunk ports are designated with the STACKPORT command in the Port Interface mode.
- ❑ If you designate more than eight ports as trunk ports on a switch, only the first eight ports function as trunk ports.
- ❑ If you designate less than two ports for the trunk on a switch, the default trunk ports are used instead.
- ❑ A trunk should not connect a switch to more than two other stack members. Building a mesh configuration where a member switch is directly connected to more than two other members is not supported and can cause unpredictable behavior.



## Planning the Stack

---

Here are factors to consider when planning a stack:

- ❑ How many x530 Series switches will be in the stack? The maximum number of switches depends on the type of trunk ports. Trunks of 10Gbps SFP+ or 5Gbps multi-speed ports support up to eight switches. Trunks of 1Gbps copper or SFP ports support up to four switches.
- ❑ The maximum number of switches depends on the type of trunk ports. Trunks of 10Gbps SFP+ or 5Gbps multi-speed ports support up to eight switches. Trunks of 1Gbps copper or SFP ports support up to four switches.
- ❑ If you are using the SFP+ ports for the trunk, have you determined the required number of SFP+ transceivers or SP10TW direct attach cables? Refer to Figure 19 on page 65 and Figure 20 on page 67.
- ❑ Have you selected a master switch? This can be any switch. If the switches has different versions of the AlliedWare Plus management software, the master switch should have the most recent version. Refer to “Master and Member Switches” on page 78.
- ❑ Have you selected the ID numbers? The range depends on the type of trunk ports. The range is 1 to 8 for stacks that use 10Gbps SFP+ or 5Gbps multi-speed ports for the trunk. The range is 1 to 4 for stacks that use 1Gbps copper or SFP ports for the trunk. Refer to “Switch ID Numbers” on page 80.
- ❑ If you are building a mixed stack of x530L switches and one or more x530 or x530DP switches, have you obtained stack mixed-mode licenses for the units?

## Configuring Mixed-Mode VCStacking

---

To configure mixed-mode VCStacking, on each unit in the stack you must:

1. Install the mixed-mode stacking license. Once you have downloaded your license, you can transfer it onto the device's Flash storage by any preferred method. For example, you can use the copy command to copy the file from a USB device to your Flash storage.
2. Enter the mixed-mode VCStacking command:

The command is: `awplus (config) # STACK MIXED-MODE`

3. Save the configuration.
4. Re-boot.

## Stacking Worksheet

---

Configuring and maintaining a stack will be easier if you use the worksheet in Table 20.

Table 20. Stacking Worksheet

Switch	Switch/Location	Switch ID	Priority	AW+ Version Number	Trunk Ports
Master		1	1		
Member		2	2		
Member		3	3		
Member		4	4		
Member		5	5		
Member		6	6		
Member		7	7		
Member		8	8		

The worksheet columns are described in Table 21.

Table 21. Stacking Worksheet Columns

Column	Description
Switch Model/ Location	Use this column to write down the model names of the switches and their physical locations, such as the buildings or equipment rooms. The information can be useful in locating the switches if they are in different locations.
ID	Each switch in a stack has to have a unique ID number. They display the numbers on the ID LEDs on the front panels and you use the numbers to configure the individual ports. Allied Telesis recommends assigning the ID 1, the default value, to the master switch. You should decide ahead of time, before beginning the configuration procedures, the ID assignments of the switches.
Priority	<p>When the switches of a stack are reset or powered on, they perform an initialization process that involves, in part, choosing the master switch. The selection is based on their priority numbers and MAC addresses. The former is an adjustable parameter with a range of 0 to 255 and a default value of 128. The lower the value, the higher the priority. Thus, the switch with the lowest value becomes the stack master.</p> <p>If switches have the same priority number, the master is selected based on their MAC addresses. Again, as with priority numbers, the lower the MAC address, the higher the priority.</p> <p>Allied Telesis recommends setting each switch's priority value to match its ID value. This is to ensure that the switch you have chosen to be the master unit will indeed function in that role. Additionally, it will make it possible for you to know the order in which the switches assume the master role if the primary master should fail or be powered off.</p>

Table 21. Stacking Worksheet Columns (Continued)

<b>Column</b>	<b>Description</b>
AW+ Version Number	This column is for writing down the version numbers of the AlliedWare Plus management software on the switches. The switches might not be able to form the stack if they have different versions. The configuration instructions explain how to view the version numbers. If they have different versions, you should update them to the most recent release before building the stack.
Trunk Ports	This column is for the trunk ports. Refer to “Stack Trunks” on page 63. You should choose the trunk ports before beginning the configuration procedures.



## Chapter 3

# Beginning the Installation

---

The chapter contains the following sections:

- “Reviewing Safety Precautions” on page 92
- “Choosing a Site for the Switch” on page 97
- “Unpacking the Switch” on page 98

## Reviewing Safety Precautions

---

Please review the following safety precautions before you begin to install the switches

**Important:** Safety statements that have the  symbol are translated into multiple languages in the *Translated Safety Statements* document, which is available at [www.alliedtelesis.com/library](http://www.alliedtelesis.com/library).

**Remarque:** Les consignes de sécurité portant le symbole  sont traduites dans plusieurs langues dans le document *Translated Safety Statements*, disponible à l'adresse [www.alliedtelesis.com/library](http://www.alliedtelesis.com/library).



**Warning**

Class 1 Laser product.  L1

---



**Warning**

Laser Radiation.  
Class 1M Laser product.

---



**Warning**

Do not stare into the laser beam.  L2

---



**Warning**

Do not look directly at the fiber optic ends or inspect the cable ends with an optical lens.  L6

---



**Warning**

To prevent electric shock, do not remove the cover. No user-serviceable parts inside. This unit contains hazardous voltages and should only be opened by a trained and qualified technician. To avoid the possibility of electric shock, disconnect electric power to the product before connecting or disconnecting the LAN cables.  E1

---



**Warning**

Do not work on equipment or cables during periods of lightning activity.  E2

---



**Warning**

Power cord is used as a disconnection device. To de-energize equipment, disconnect the power cord. ⚡ E3

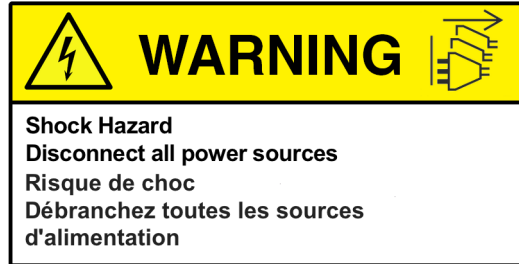
**Warning**

Class I Equipment. This equipment must be earthed. The power plug must be connected to a properly wired earth ground socket outlet. An improperly wired socket outlet could place hazardous voltages on accessible metal parts. ⚡ E4

**Note**

Pluggable Equipment. The socket outlet shall be installed near the equipment and shall be easily accessible. ⚡ E5

**Caution**

Air vents must not be blocked and must have free access to the room ambient air for cooling. ⚡ E6

**Warning**

Operating Temperatures. This product is designed for a maximum ambient temperature of 50° C. See footnote for Table 31 on page 194. ⚡ E52

**Note**

All Countries: Install product in accordance with local and National Electrical Codes. ⚡ E8

**Warning**

Only trained and qualified personnel are allowed to install or replace this equipment. ⚡ E14



**Caution**

Circuit Overloading: Consideration should be given to the connection of the equipment to the supply circuit and the effect that overloading of circuits might have on overcurrent protection and supply wiring. Appropriate consideration of equipment nameplate ratings should be used when addressing this concern. *↪* E21

---



**Caution**

Risk of explosion if battery is replaced by an incorrect type. Replace only with the same or equivalent type recommended by the manufacturer. Dispose of used batteries according to the manufacturer's instructions.

**Attention:** Le remplacement de la batterie par une batterie de type incorrect peut provoquer un danger d'explosion. La remplacer uniquement par une batterie du même type ou de type équivalent recommandée par le constructeur. Les batteries doivent être éliminées conformément aux instructions du constructeur. *↪* E22

---



**Warning**

Mounting of the equipment in the rack should be such that a hazardous condition is not created due to uneven mechanical loading. *↪* E25

---



**Warning**

The chassis may be heavy and awkward to lift. Allied Telesis recommends that you get assistance when mounting the chassis in an equipment rack. *↪* E28

---

---

**Note**

Use dedicated power circuits or power conditioners to supply reliable electrical power to the device. *↪* E27

---



**Warning**

This unit might have more than one power cord. To reduce the risk of electric shock, disconnect all power cords before servicing the unit. *↪* E30

---

---

**Note**

If installed in a closed or multi-unit rack assembly, the operating ambient temperature of the rack environment may be greater than the room ambient temperature. Therefore, consideration should be given to installing the equipment in an environment compatible with the manufacturer's maximum rated ambient temperature (Tmra).

 E35

---



---

**Caution**

Installation of the equipment in a rack should be such that the amount of air flow required for safe operation of the equipment is not compromised.  E36

---



---

**Warning**

Reliable earthing of rack-mounted equipment must be maintained. Particular attention must be given to supply connections other than direct connections to the branch circuits (e.g., use of power strips).

 E37

---



---

**Warning**

To reduce the risk of electric shock, the PoE ports on this product must not connect to cabling that is routed outside the building where this device is located.  E40

---



---

**Warning**

This product may have multiple AC power cords installed. To de-energize this equipment, disconnect all power cords from the device.

 E41

---



---

**Caution**

The unit does not contain serviceable components. Please return damaged units for servicing.  E42

---



---

**Warning**

The temperature of an operational SFP or SFP+ transceiver may exceed 70° C (158° F). Exercise caution when removing or handling a transceiver with unprotected hands.  E43

---



---

**Caution**

An Energy Hazard exists inside this equipment. Do not insert hands or tools into open chassis ports or plugs. ⚡ E44

---

## Choosing a Site for the Switch

---

Observe these requirements when planning the installation of the switch.

- ❑ If you plan to install the switch in an equipment rack, check to be sure that the rack is safely secured so that it will not tip over. Devices in a rack should be installed starting at the bottom, with the heavier devices near the bottom of the rack.
- ❑ If you plan to install the switch on a table, check to be sure that the table is level and stable.
- ❑ The power outlet should be located near the switch and be easily accessible.
- ❑ The site should allow for easy access to the ports on the front of the switch, so that you can easily connect and disconnect cables, and view the port LEDs.
- ❑ The site should allow for adequate air flow around the unit and through the cooling vents on the front and rear panels. (The ventilation direction in units that have a cooling fan is from front to back, with the fan on the back panel drawing the air out of the unit.)
- ❑ The site should not expose the switch to moisture or water.
- ❑ The site should be a dust-free environment.
- ❑ The site should include dedicated power circuits or power conditioners to supply reliable electrical power to the network devices.
- ❑ Do not install the switch in a wiring or utility box because it will overheat and fail from inadequate airflow.



### Warning

Switches should not be stacked on a table or desktop. They could present a physical safety hazard if you need to move or replace switches. ⚡ E91

---

## Unpacking the Switch

The main items provided in the shipping box for the switch are:

- ❑ x530 Series switch
- ❑ Accessory kit (refer to Figure 31 on page 99)

---

**Note**

Retain the original packaging material in case you need to return the unit to Allied Telesis.

---

Figure 30 shows the items provided in the shipping box for the switch.

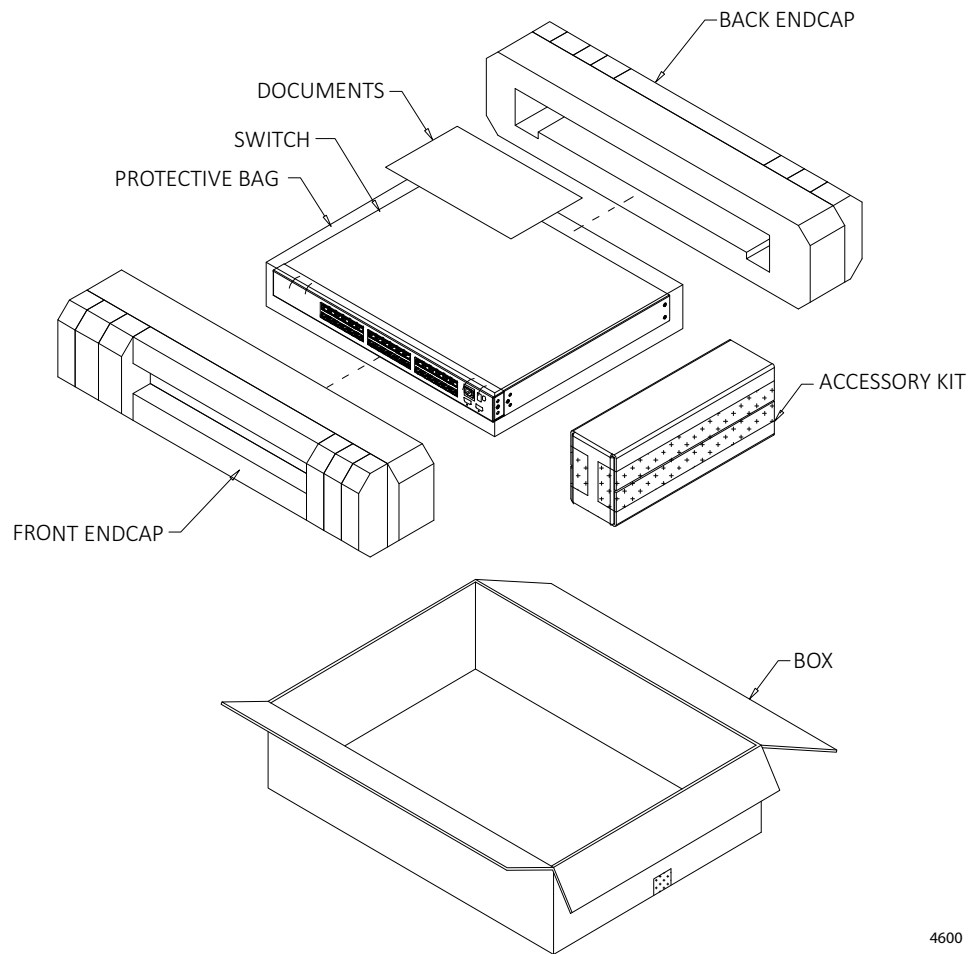
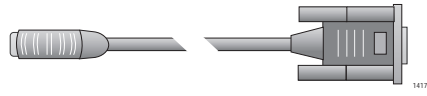
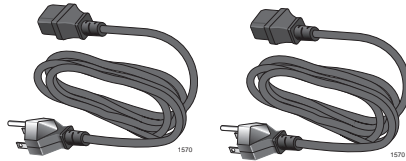

Figure 30. Switch Shipping Box

Figure 31 lists the items that are included in the accessory kit for the x530-28GPXm, x530-28GTxm, x530-28GSX, x530-52GPXm, and x530-52GTxm. Contact your Allied Telesis sales representative for assistance if any item is missing or damaged.



One 2m (6.6 ft) local management cable with RJ-45 (8P8C) and DB-9 (D-sub 9-pin) connectors.



Two regional AC power cords.

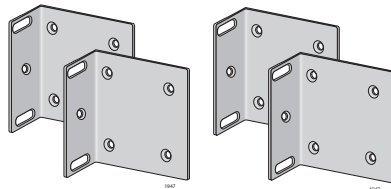

Two or four wall/equipment rack brackets depending on the model.



Eight or sixteen screws for attaching the wall/equipment rack brackets depending on the model.  
Length: 6.0mm (0.2 in.)  
Diameter: 4.0mm (0.2 in.)

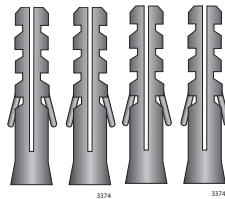

Two or four anchors for concrete walls depending on the model.  
Length: 29.6mm (1.2 in.)  
Diameter: 6.0mm (0.2 in.)

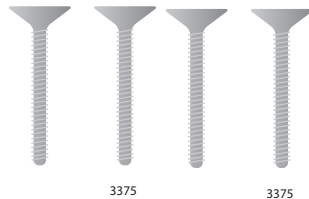

Two or four screws for wood or concrete walls depending on the model.  
Length: 32mm (1.3 in.)  
Diameter: 4mm (0.2 in.)



Two power cord retaining clips

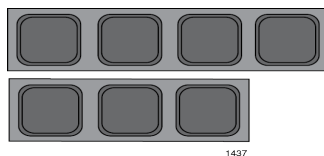

Seven rubber feet

Figure 31. Accessory Kit Items

Figure 32 lists the items that are included in the accessory kit for the x530-10GHXm and x530-18GHXm. Contact your Allied Telesis sales representative for assistance if any item is missing or damaged.

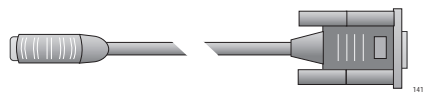

One 2m (6.6 ft) local management cable with RJ-45 (8P8C) and DB-9 (D-sub 9-pin) connectors.

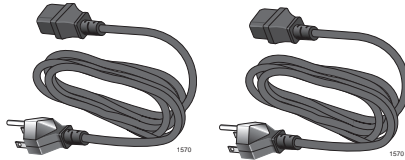

Two regional AC power cords.

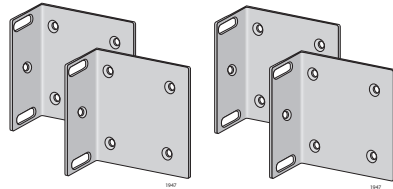

Two or four wall/equipment rack brackets depending on the model.

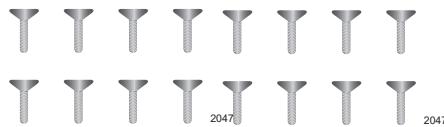

Eight or sixteen screws for attaching the wall/equipment rack brackets depending on the model.  
Length: 6.0mm (0.2 in.)  
Diameter: 4.0mm (0.2 in.)

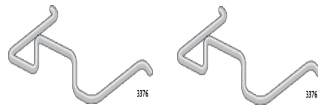

Two power cord retaining clips

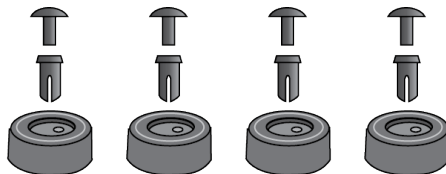

Four bumper feet with rivets

Figure 32. Accessory Kit Items



Table 22 lists the items that come in the accessory kit for each switch.

Table 22. Accessory Kit Items

<b>Accessory Kit Items</b>	<b>x530-10GHXm (PoE++)</b>	<b>x530-18GHXm (PoE++)</b>	<b>x530-28GTxm</b>	<b>x530-28GPxm (PoE+)</b>	<b>x530-28GSX</b>	<b>x530-52GTxm</b>	<b>x530-52GPxm (PoE+)</b>
Management cable	1	1	1	1	1	1	1
Power cords	2	2	2	2	2	2	2
Wall/equipment rack brackets	4	4	2	2	2	4	4
Wall/equipment rack bracket screws	16	16	8	8	8	16	16
Wall anchors	0	0	2	2	2	4	4
Wall screws	0	0	2	2	2	4	4
Power cord retaining clips	2	2	2	2	2	2	2
Rubber feet	0	0	7	7	7	7	7
Bumper feet with rivets	4	4	0	0	0	0	0



## Chapter 4

# Installing the Switch on a Table

---

This chapter contains the instructions for installing the switch on a table or desktop.

- ❑ “Installing the Rubber Feet on the Switch” on page 104
- ❑ “Placing the Switch on a Desk or Table” on page 108



### **Warning**

Switches should not be stacked on a table or desktop. They could present a physical safety hazard if you need to move or replace switches.  E91

---



### **Warning**

The switch is heavy. Always ask for assistance when moving or lifting the device so as to avoid injuring yourself or damaging the equipment.  E122

---

## Installing the Rubber Feet on the Switch

---

The x530-28GPXm, x530-28GTXm, x530-28GSX, x530-52GPXm, and x530-52GTXm switches come with seven rubber feet in the accessory kit. The feet, which are reusable, are used when installing the switch on a table.

---

### Note

Although you cannot stack the switches on top of each other, they can be placed next to each other.

---

---

### Note

The following procedure assumes that you have already reviewed the information and performed the procedures in Chapter 3, “Beginning the Installation” on page 91.

---



---

### Warning

The switch is heavy. Always ask for assistance when moving or lifting the device so as to avoid injuring yourself or damaging the equipment.

---

To install the rubber feet on the underside of the switch, perform the following procedure:

1. Place the switch upside down on a table.
2. Affix the seven rubber feet to the square indentations on the bottom panel of the switch

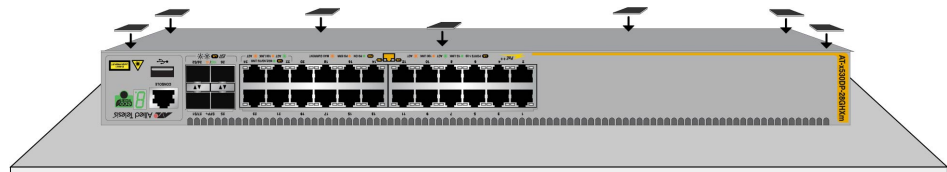

3. Turn the switch over and place it on a flat, secure desk or table, leaving ample space around it for ventilation.

## Installing the Bumper Feet with Rivets on the Switch

---

The x530-10GHXm and x530-18GHXm switches come with four bumper feet in the accessory kit. The feet, which are reusable, are used when installing the switch on a table. If they are already assembled, disassemble them by removing the rivets and rivet housings from the bumper feet. Refer to Figure 33.

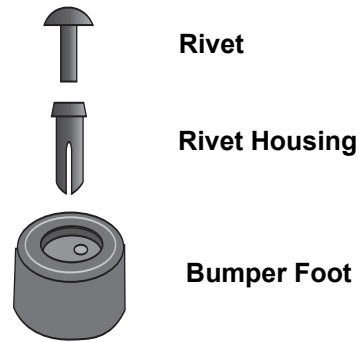

Figure 33. Parts of the Bumper Feet

---

**Note**

The following procedure assumes that you have already reviewed the information and performed the procedures in Chapter 3, “Beginning the Installation” on page 91.

---

The holes in the base of the switch for the bumper feet are shown in Figure 34.

---

**Note**

Although you cannot stack the switches on top of each other, they can be placed next to each other.

---

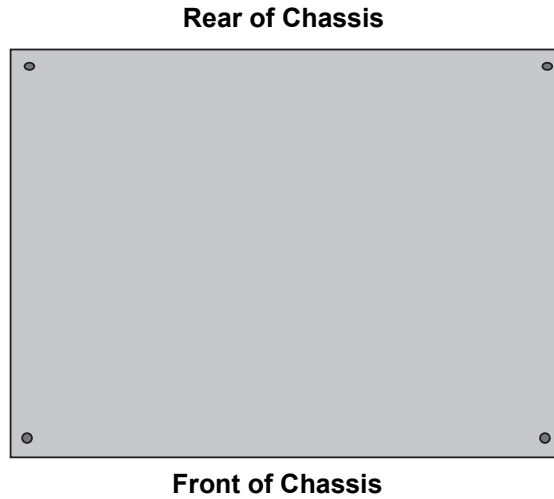

Figure 34. Holes for Bumper Feet

To install the switch on a table, perform the following procedure:

1. Place the switch upside down on a table.
2. Insert a rivet housing into a bumper foot. Refer to Figure 35.

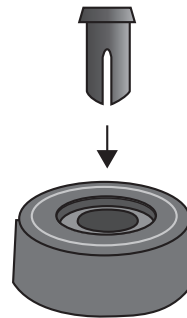

Figure 35. Inserting the Rivet Housing into the Bumper Foot

3. Place the bumper foot with rivet housing onto one of the holes in the base of the switch. Refer to Figure 36.

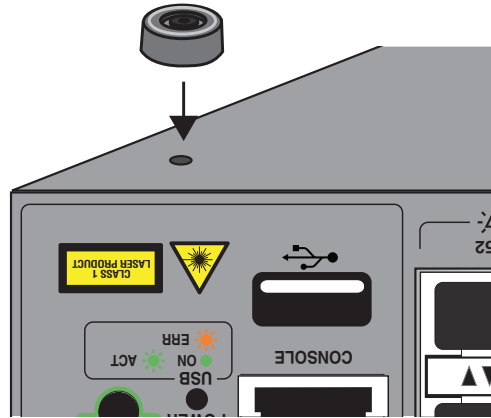

Figure 36. Placing the Bumper Foot on a Base Corner Hole

4. Insert the rivet to secure the bumper foot to the base. Refer to Figure 37 on page 107.

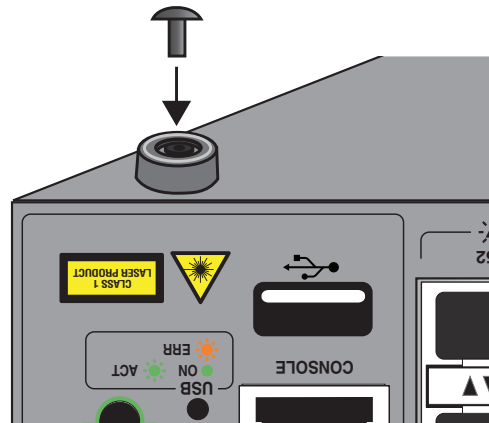

Figure 37. Inserting the Rivet into the Bumper Foot

5. Repeat steps 2 to 4 to install the remaining bumper feet.
6. Turn the switch over and place it on a flat, secure desk or table, leaving ample space around it for ventilation.

## Placing the Switch on a Desk or Table

---

To install the switch on a table, perform the following procedure:

1. Place the switch on a flat, secure desk or table, leaving ample space around it for ventilation.



### **Warning**

The switch is heavy. Always ask for assistance when moving or lifting the device so as to avoid injuring yourself or damaging the equipment. ⚡ E122

---

2. Repeat this procedure on any other switches that are to be installed a table or desktop.
3. After installing the switches, go to Chapter 7, “Building the Trunk with the Default SFP+ S1 and S2 10Gbps Stacking Ports” on page 131 or Chapter 8, “Building the Stack with Gigabit or 5G Multi-speed Ports” on page 149.



## Chapter 5

# Installing the Switch in an Equipment Rack

---

This chapter provides instructions for installing the switch in an equipment rack. This chapter contains the following section:

- “Beginning the Installation” on page 110
- “Installing the Switch” on page 112

## Beginning the Installation

---

This section contains the procedure for installing the switch in a standard 19-inch equipment rack using the brackets supplied with the unit.

### Required Items

The following items are required to install the switch in an equipment rack:

- ❑ Two or four (depending on model) equipment rack brackets (included with the switch)
- ❑ Eight or sixteen (depending on model) M4x6mm bracket screws (included with the switch)
- ❑ Cross-head screwdriver (not provided)
- ❑ Four standard equipment rack screws (not provided)

### Switch Orientations in the Equipment Rack

The switch has two sets of four screw holes on the left and right sides, for attaching the brackets. Refer to Figure 38.

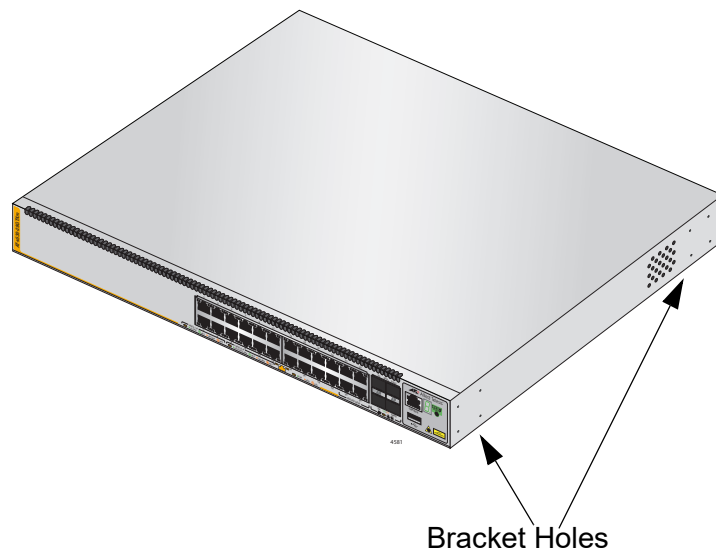

Figure 38. Bracket Holes on the Switch

You can use the different sets of holes on the switch to install the switch in the equipment rack in a variety of orientations. You can install it with the front panel flush with, extending in front of, or recessed behind the front of the equipment rack. Refer to Figure 39.



Figure 39. Switch Orientations in an Equipment Rack

## Installing the Switch

---

If you have not chosen an orientation for the switch in the equipment rack, review “Switch Orientations in the Equipment Rack” on page 110.

Please review the installation guidelines in “Choosing a Site for the Switch” on page 97 before installing the switch in an equipment rack.



---

**Caution**

The chassis can be heavy and awkward to lift. Allied Telesis recommends that you get assistance when mounting the chassis in an equipment rack. *GE E28*

---

To install the switch in a 19-inch equipment rack, perform the following procedure:

1. Place the switch on a level, secure surface.
2. Attach the two brackets to the sides of the switch in the selected position, using the eight M4x6mm screws supplied with the unit. The illustration in Figure 40 shows the installation of the brackets such that the front panel of the switch is even with the front of the equipment rack.

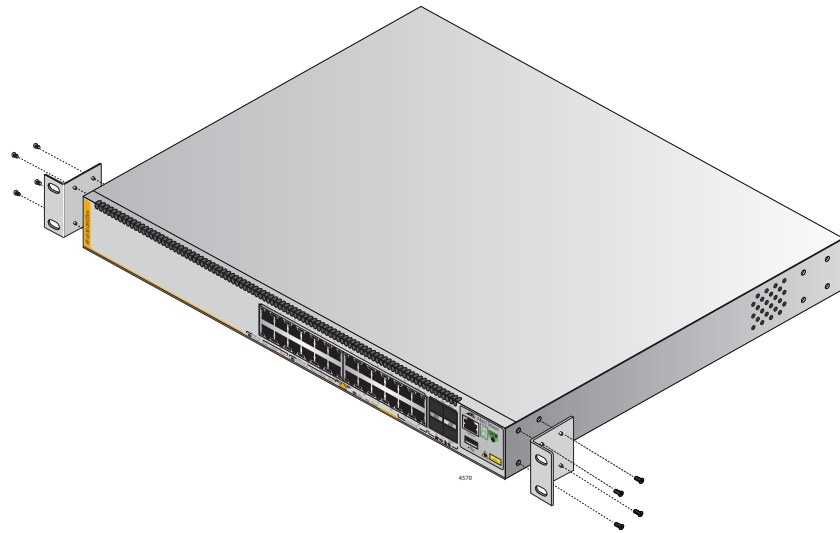

Figure 40. Example of Attaching the Brackets to the Switch

3. Have another person hold the switch at the desired location in the equipment rack while you secure it using four standard equipment rack screws (not provided). Refer to Figure 41.

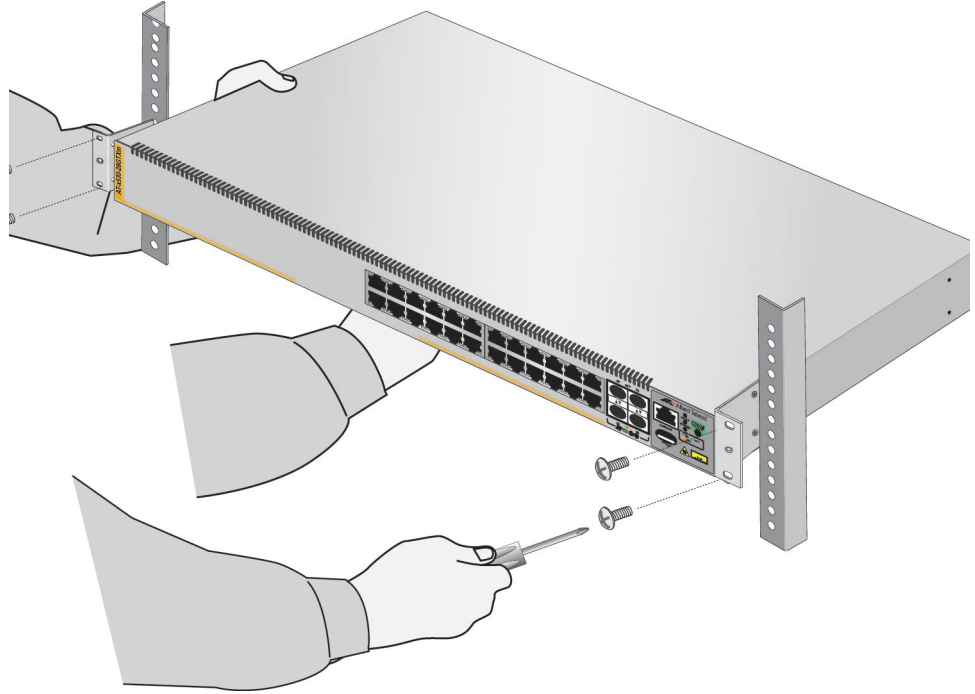

Figure 41. Installing the Switch in an Equipment Rack

4. Install the other switches of the stack.
5. After installing the switches, go to Chapter 7, “Building the Trunk with the Default SFP+ S1 and S2 10Gbps Stacking Ports” on page 131 or Chapter 8, “Building the Stack with Gigabit or 5G Multi-speed Ports” on page 149.



## Chapter 6

# Installing the Switch on a Wall

---

The procedures in this chapter are listed here:

- ❑ “Switch Orientations on a Wall” on page 116
- ❑ “Installation Guidelines” on page 118
- ❑ “Plywood Base for a Wall with Wooden Studs” on page 120
- ❑ “Installing a Plywood Base” on page 121
- ❑ “Installing the Switch on a Plywood Base” on page 122
- ❑ “Installing the Switch on a Concrete Wall” on page 127

## Switch Orientations on a Wall

---

Follow these guidelines for positioning the switch on a wall:

- ❑ Install the x530-28GTXm or x530-28GSX switch on a wall with the front panel facing up, left or right, as shown in Figure 42. Do not install the switch with the front panel facing down.
- ❑ Install the x530-10GHXm, x530-18GHXm, x530-28GPXm, x530-52GTXm, or x530-52GPXm switch on a wall with the front panel facing left or right, as shown in Figure 43. Do not install the switch with the front panel facing up or down.



Figure 42. Positioning the x530-28GTXm or x530-28GSX Switch on the Wall



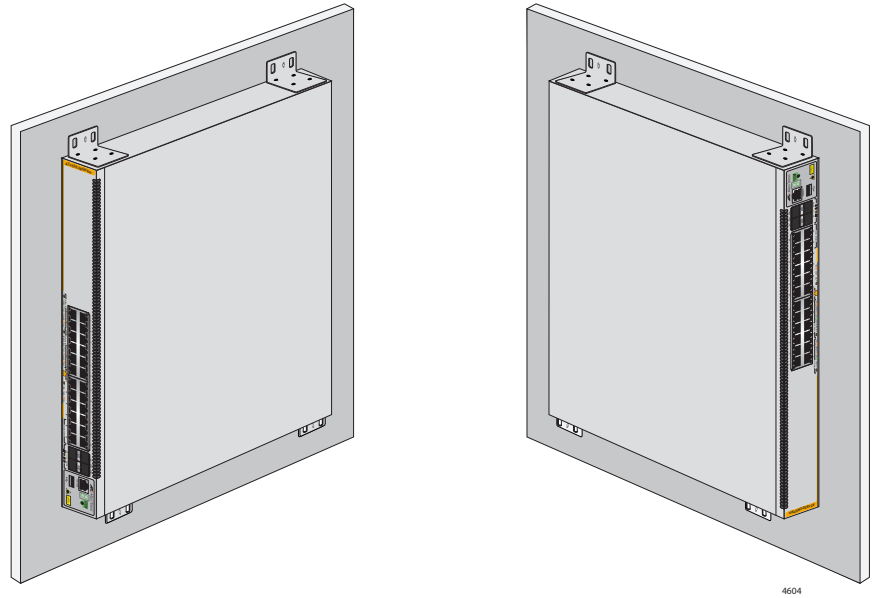

Figure 43. Positioning the x530-10GHXm, x530-18GHXm, x530-28GPXm, x530-52GTXm, or x530-52GPXm Switch on the Wall

## Installation Guidelines

---

Here are the guidelines for installing the switch on a wall:

- ❑ Install the switch on a wall that has wooden studs or on a concrete wall.
- ❑ If you are installing the switch on a wall with wooden studs, use a plywood base to support the switch. For more information, refer to “Plywood Base for a Wall with Wooden Studs” on page 120. A plywood base is not required for a concrete wall.
- ❑ Do not install the switch on a wall that has metal studs. Metal studs may not be strong enough to safely support the device.
- ❑ Do not install the switch on sheetrock or similar material. Sheetrock is not strong enough to safely support the device.



### Warning

The device is heavy. Always ask for assistance before moving or lifting it to avoid injuring yourself or damaging the equipment.

---



### Warning

The device should be installed on a wall by a qualified building contractor. Serious injury to yourself or others or damage to the equipment can result if it is not properly fastened to the wall. ⚡  
E105

---

## Tools and Material

The following tools and material are required for installing the switch on a wall.

Included with switch:

- ❑ Wall/equipment rack brackets:
  - Two for the x530-28GTXm or x530-28GSX switch
  - Four for the x530-10GHXm, x530-18GHXm, x530-28GPXm, x530-52GTXm or x530-52GPXm switch
- ❑ Screws for attaching the wall/equipment rack brackets to the switch:
  - Eight for the x530-28GTXm or x530-28GSX switch
  - Sixteen for the x530-10GHXm, x530-18GHXm, x530-28GPXm, x530-52GTXm or x530-52GPXm switch

Length: 6 mm (0.2 in.) Diameter: 4 mm (0.2 in.)

- ❑ Anchors for concrete walls
  - Two for the x530-28GTXm or x530-28GSX switch
  - Four for the x530-10GHXm, x530-18GHXm, x530-28GPXm, x530-52GTXm or x530-52GPXm switch

Length: 29.6 mm (1.2 in.) Diameter: 6 mm (0.2 in.)

- ❑ Screws for wood or concrete walls:
  - Two for the x530-28GTXm or x530-28GSX switch
  - Four for the x530-10GHXm, x530-18GHXm, x530-28GPXm, x530-52GTXm or x530-52GPXm switch

Length: 32 mm (1.3 in.) Diameter: 4 mm (0.2 in.)

- ❑ Two power cord retaining clips
- ❑ Seven rubber feet

Not included with switch:

- ❑ Cross-head screwdriver.
- ❑ Stud finder for a wooden wall, capable of identifying the middle of wall studs and hot electrical wiring.
- ❑ Drill and 1/4-inch carbide drill bit (for a concrete wall). Refer to “Installing the Switch on a Concrete Wall” on page 127.
- ❑ Plywood base (if you are installing the switch on a wall with wooden studs). Refer to “Plywood Base for a Wall with Wooden Studs” on page 120 for illustrations.
- ❑ Four screws for attaching the plywood base to the wall.



### Caution

The supplied screws and anchors might not be appropriate for all walls. A qualified building contractor can determine the hardware requirements for your wall prior to installing the switch. *E88*

---

## Plywood Base for a Wall with Wooden Studs

---

If you are installing the switch on a wall that has wooden studs, use a plywood base for the device. (A plywood base is not required for a concrete wall.) Refer to Figure 44.

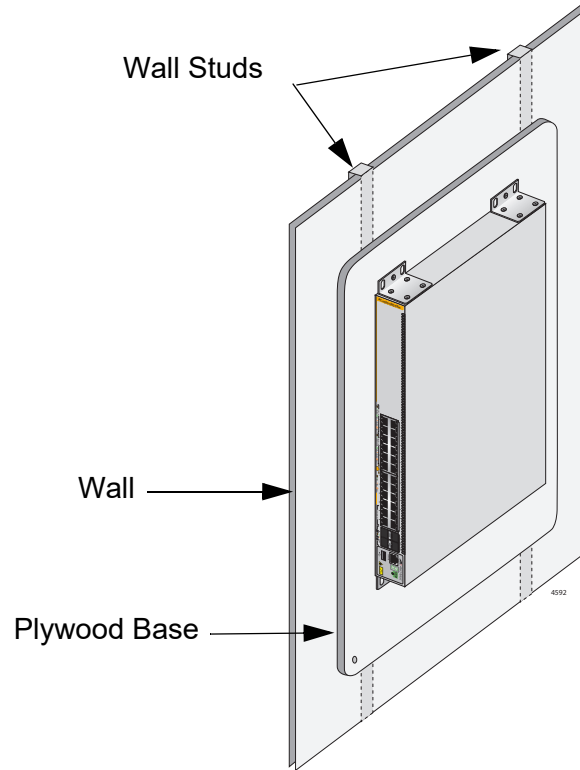

Figure 44. Switch on the Wall with a Plywood Base

Mount the plywood base to two studs in the wall. The recommended minimum dimensions of the plywood base for the switch is:

- ❑ Width: 55.9 centimeters (22 inches)
- ❑ Height: 61.0 centimeters (24 inches)
- ❑ Thickness: 2.5 centimeters (1 inch)

The dimensions assume the wall studs are 41 centimeters (16 inches) apart. You might need to adjust the width of the base if the distance between the studs in your wall is different than the industry standard.

## Installing a Plywood Base

---

A plywood base is recommended when installing the switch on a wall that has wooden studs. Refer to “Plywood Base for a Wall with Wooden Studs” on page 120. Consult a qualified building contractor for installation instructions for the plywood base. The installation guidelines are listed here:

- ❑ Use a stud finder to identify the middle of studs and hot electrical wiring in the wall.
- ❑ Attach the base to two wall studs with a minimum of four screws.
- ❑ The selected wall location for the base must provide sufficient space from other devices or walls so that you can access the front and back panels, and for adequate air flow for ventilation.

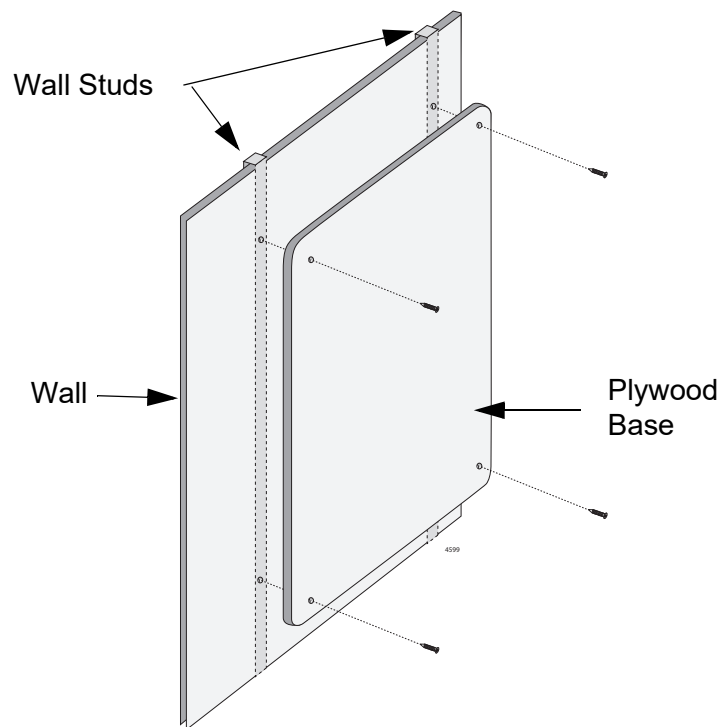

Figure 45. Installing the Plywood Base to the Wall

## Installing the Switch on a Plywood Base

---

After the plywood base for the switch has been installed on the wall, install the switch. See “Reviewing Safety Precautions” on page 92 and “Choosing a Site for the Switch” on page 97 before performing this procedure. Allied Telesis recommends a minimum of two people for this procedure.



### Warning

The device is heavy. Always ask for assistance before moving or lifting it to avoid injuring yourself or damaging the equipment.

---



### Warning

The device should be installed on the wall by a qualified building contractor. Serious injury to yourself or others or damage to the equipment can result if it is not properly fastened to the wall. *ES*  
E105

---

To install the switch on the plywood base, perform the following procedure:

1. Place the switch on a table.
2. For the x530-28GTXm or x530-28GSX switch, install two wall/equipment rack brackets to the sides of the unit with the eight M4x6mm screws included with the switch. Refer to Figure 46 on page 123. For the x530-10GHXm, x530-18GHXm, x530-28GPXm, x530-52GPXm or x530-52GTXm switch, install four wall/equipment rack brackets to the sides of the unit with the 16 M4x6mm screws included with the switch. Refer to Figure 47 on page 124.

---

### Note

The x530-10GHXm, x530-18GHXm, x530-28GPXm, x530-52GPXm or x530-52GTXm switch requires four brackets to be installed due to its weight. Whereas, the x530-28GTXm or x530-28GSX switch only requires two brackets because it is lighter.

---

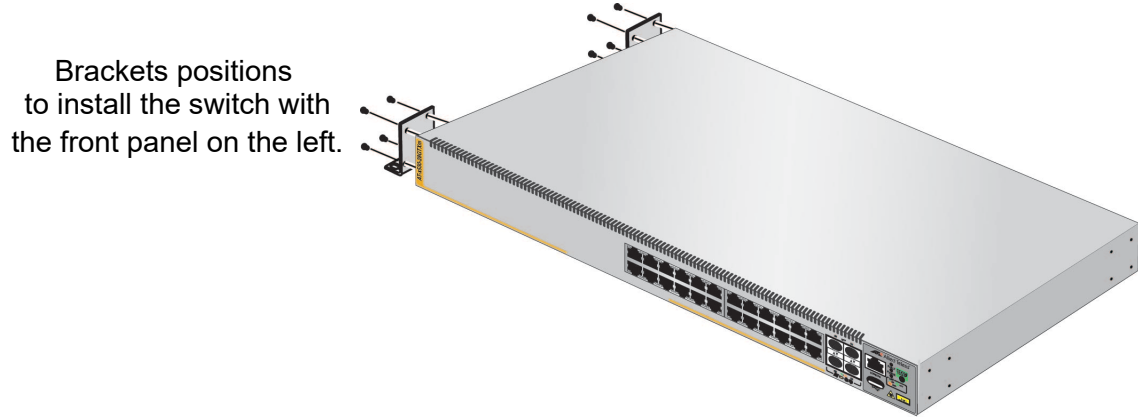

Figure 46. Installing Two Brackets on the x530-28GTXm or x530-28GSX Switch

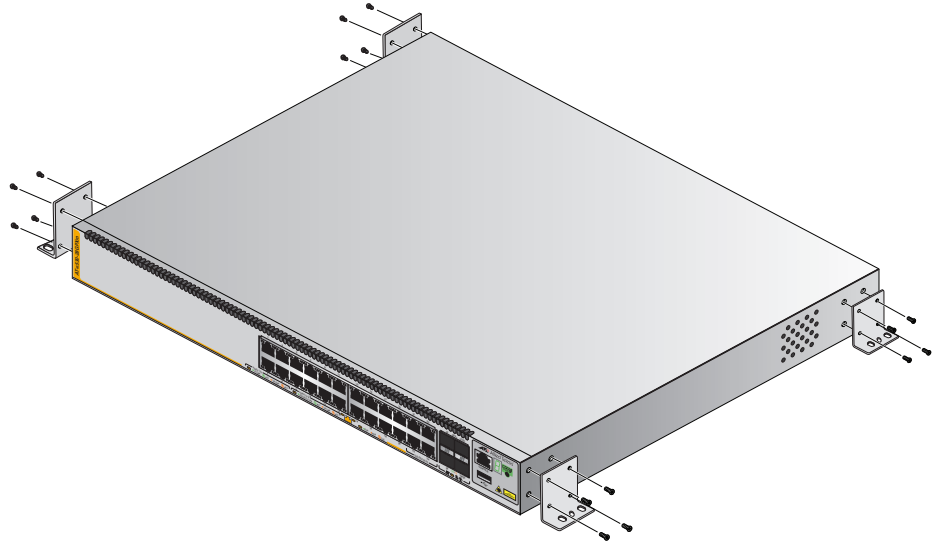

Figure 47. Installing Four Brackets on the x530-10GHXm, x530-18GHXm, x530-28GPXm, x530-52GTXm or x530-52GPXm Switch

3. After attaching the brackets, have another person hold the switch on the plywood base on the wall while you secure it with the M4x32.3mm screws included with the switch. Refer to Figure 48 on page 125 for the x530-28GTXm or x530-28GSXswitch. Refer to Figure 49 on page 126 for the x530-10GHXm, x530-18GHXm, x530-28GPXm, x530-52GTXm or x530-52GPXm switch.

Follow these guidelines as you position the switch on the wall:

- Position it so that the front panel is facing up, left or right. Refer to Figure 42 on page 116. Do not install it with the front panel facing down.
- Provide sufficient space from other devices or walls so that you can access the front and back panels, and for adequate air flow for ventilation.



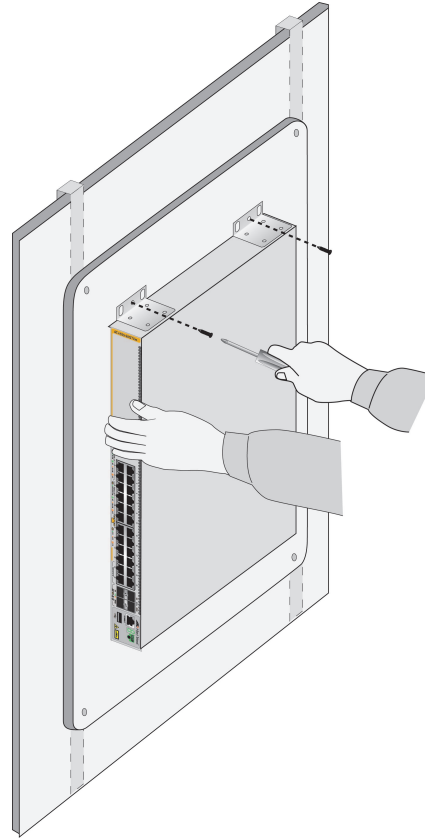

Figure 48. Securing the x530-28GTXm or x530-28GSX Switch to the Plywood Base

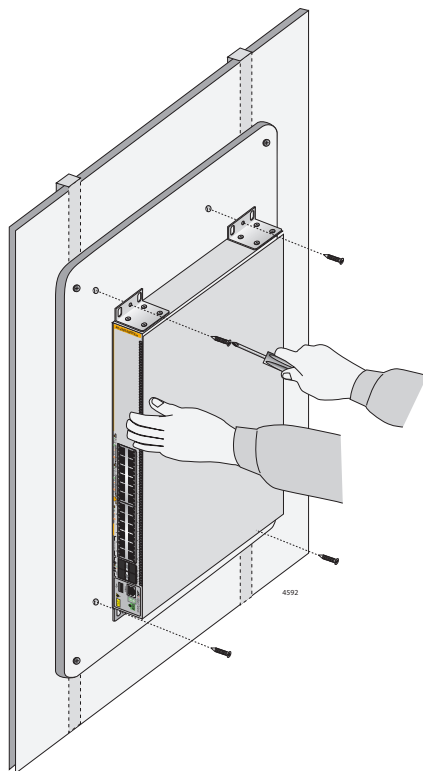

Figure 49. Securing the x530-10GHXm, x530-18GHXm, x530-28GPXm, x530-52GTXm or x530-52GPXm Switch to the Plywood Base

4. Install the other switches of the stack.
5. Go to Chapter 7, “Building the Trunk with the Default SFP+ S1 and S2 10Gbps Stacking Ports” on page 131 or Chapter 8, “Building the Stack with Gigabit or 5G Multi-speed Ports” on page 149.

## Installing the Switch on a Concrete Wall

---

This section contains the instructions for installing the switch on a concrete wall. Please review the information in the following sections before performing the procedure:

- “Switch Orientations on a Wall” on page 116
- “Installation Guidelines” on page 118



---

### Warning

The device is heavy. Always ask for assistance before moving or lifting it to avoid injuring yourself or damaging the equipment.

---



---

### Warning

The device should be installed on the wall by a qualified building contractor. Serious injury to yourself or others or damage to the equipment can result if it is not properly fastened to the wall. *ES*  
E105

---

To install the switch on a concrete wall, perform the following procedure:

1. Place the switch on a table.
2. For the x530-28GTXm or x530-28GSX switch, install two wall/equipment rack brackets to the sides of the unit with the eight M4x6mm screws included with the switch. Refer to Figure 46 on page 123. For the x530-10GHXm, x530-18GHXm, x530-28GPXm, x530-52GTXm or x530-52GPXm switch, install four wall/equipment rack brackets to the sides of the unit with the 16 M4x6mm screws included with the switch. Refer to Figure 47 on page 124.
3. After attaching the brackets, have another person hold the switch on the concrete wall at the selected location for the device while you use a pencil or pen to mark the wall with the locations of the screw holes in the brackets (one screw per bracket). Refer to Figure 50 on page 128.

Please follow these guidelines as you position the switch on the wall:

- Install the x530-28GTXm or x530-28GSX switch on a wall with the front panel facing up, left or right, as shown in Figure 42 on page 116. Do not install the switch with the front panel facing down.
- Install the x530-10GHXm, x530-18GHXm, x530-28GPXm, x530-52GTXm, or x530-52GPXm Switch on a wall with the front panel facing left or right, as shown in Figure 43 on page 117. Do not install the switch with the front panel facing up or down.

- ❑ Provide sufficient space from other devices or walls so that you can access the front and back panels, and for adequate air flow and ventilation.

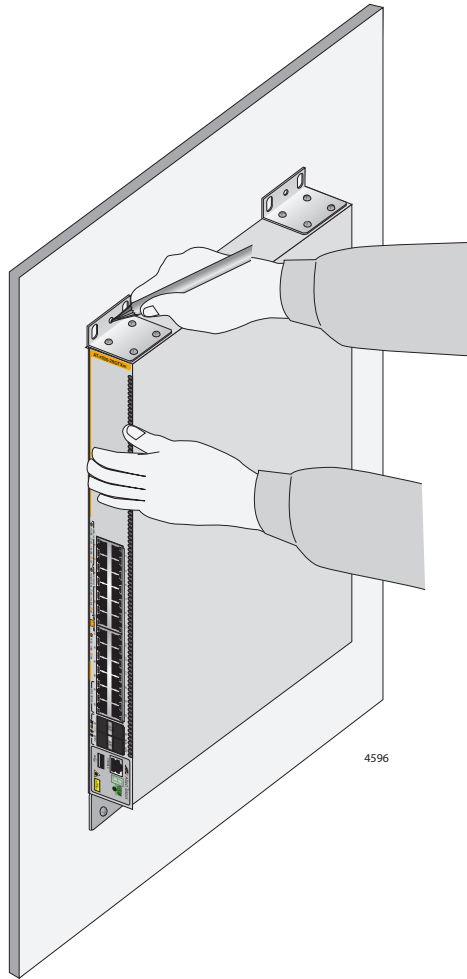

Figure 50. Marking the Locations of the Bracket Holes on a Concrete Wall

4. Place the switch on a table.
5. Use a drill and a 1/4-inch carbide drill bit to pre-drill the holes you marked in step 3. Please review the following guidelines:
  - ❑ Prior to drilling, set the drill to hammer and rotation mode. The modes break up the concrete and clean out the hole.
  - ❑ Clean out the holes with a brush or compressed air.
6. Insert the anchors into the holes.

7. Have another person hold the switch at the selected wall location while you secure it to the wall with the M4x32mm screws provided. Refer to Figure 51.

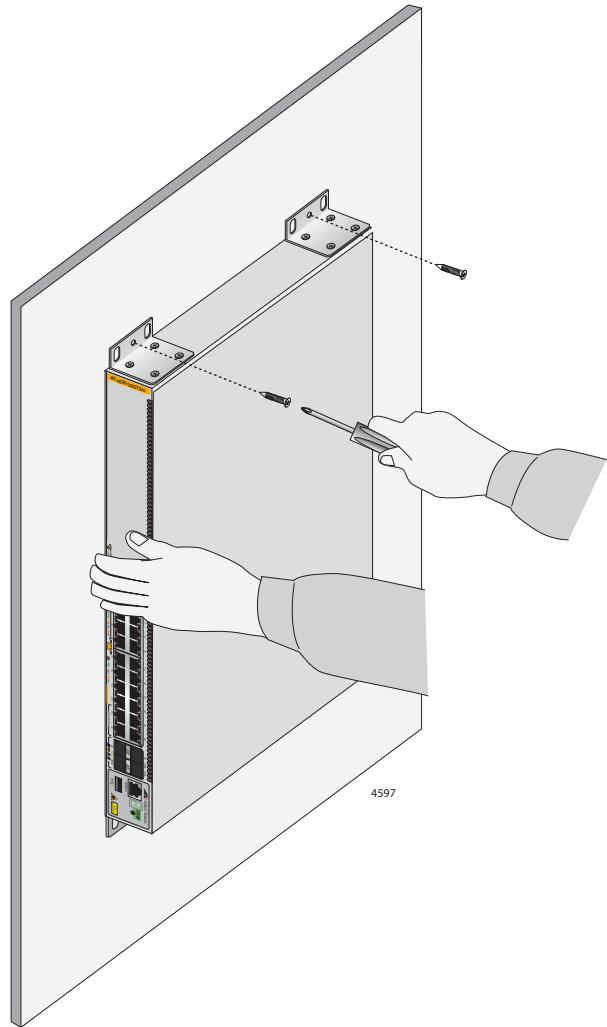

Figure 51. Installing the Switch on a Concrete Wall

8. Install the other switches of the stack.
9. Go to Chapter 7, “Building the Trunk with the Default SFP+ S1 and S2 10Gbps Stacking Ports” on page 131 or Chapter 8, “Building the Stack with Gigabit or 5G Multi-speed Ports” on page 149.



## Chapter 7

# Building the Trunk with the Default SFP+ S1 and S2 10Gbps Stacking Ports

---

This chapter contains the following procedures:

- ❑ “Introduction” on page 132
- ❑ “Powering On the Switches Sequentially” on page 133
- ❑ “Powering On the Switches Simultaneously” on page 136
- ❑ “Starting a Management Session” on page 138
- ❑ “Verifying the Stack” on page 143
- ❑ “Adding SFP+ Ports to the Stack Trunk” on page 144
- ❑ “Powering on a Switch” on page 146

## Introduction

---

This chapter contains instructions for building the stack using the default SFP+ S1 and S2 10Gbps ports as the trunk. The procedure does not require any configuration steps because the stacking feature is enabled by default. The default stacking ports are:

- ❑ x530-10GHXm: SFP+ ports 9/S1 and 10/S2
- ❑ x530-18GHXm: SFP+ ports 17/S1 and 18/S2
- ❑ x530-28GTXm, x530-28GPXm or x530-28GSX: SFP+ ports 27/S1 and 28/S2
- ❑ x530-52GTXm or x530-52GPXm: SFP+ ports 51/S1 and 52/S2

To build the stack, you cable the S1 and S2 ports and power on the switches.

There are two procedures:

- ❑ To control the assignment of the switch ID numbers yourself, perform “Powering On the Switches Sequentially” on page 133. The numbers are assigned in the order in which you power on the units.
- ❑ To have the switches assign the ID numbers automatically, perform “Powering On the Switches Simultaneously” on page 136.



### Caution

Do not change the ID numbers of the switches after beginning to configure the parameter settings. Otherwise, the stack might assign configuration settings to the wrong units.

---

### Note

As explained in “Stack Trunks” on page 63, you can connect the same ports together (e.g., S1 to S1 and S2 to S2) or you can cross them over (e.g., S1 to S2 and S2 to S1). Allied Telesis recommends the latter.

---



## Powering On the Switches Sequentially

---

This procedure explains how to control the assignment of the ID numbers of the switches by powering on the units one at a time during the first power-on sequence. The first switch is assigned ID number 1, the next unit ID number 2, and so on. This procedure is useful when the switches are installed in the same equipment rack. You can number them in sequence, such as from top to bottom, to make them easier to identify.

In this procedure the first switch powered on becomes the master switch of the stack. If you do not change the priority values of the switches and later reset or power cycle the stack, the switches will select the master based on their MAC addresses. This could result in a different switch becoming the master. However, this does not change their ID numbers, the stack configuration, or the manner in which you manage the stack.

This procedure assumes the following:

- This is the first power-on sequence of the stack.
- You cabled ports on the switches to form the stack trunk.
  - x530-10GHXm: SFP+ ports 9/S1 and 10/S2
  - x530-18GHXm: SFP+ ports 17/S1 and 18/S2
  - x530-28GTXm, x530-28GPXm or x530-28GSX: SFP+ ports 27/S1 and 28/S2
  - x530-52GTXm or x530-52GPXm: SFP+ ports 51/S1 and 52/S2

---

### Note

For example, when cabling ports 27/S1 and 28/S2 (or 51/S1 and 52/S2) for the stack trunk, you can either connect the same ports together, for example, (27/S1 to 27/S1 and 28/S2 to 28/S2) or you can cross them over (27/S1 to 28/S2). The latter is recommended but not mandatory.

---

- The switches are at their default settings.
- The switches are powered off.

To monitor the power on sequence, you can connect a terminal or computer with a terminal emulator program to the Console port on the switch you intend to power on first. For the terminal settings, refer to “Starting a Management Session” on page 138.

---

### Note

Before powering on the switch, refer to “Power Specifications” on page 195 for the power specifications of the switches.

---

To power on the stack for the first time and control the assignment of the ID numbers, perform the following procedure:

1. If you have not already cabled ports, do so now. For background information, refer to “Stack Trunks” on page 63, For cabling instructions, refer to Chapter 9, “Cabling Copper Ports” on page 174.
2. Power on the switch you want assigned ID number 1. Connect its power cord to the AC connector on the back panel and to an appropriate power source. Refer to “Powering on a Switch” on page 146.



---

**Warning**

Power cord is used as a disconnection device. To de-energize equipment, disconnect the power cord. ⚡ E3

---

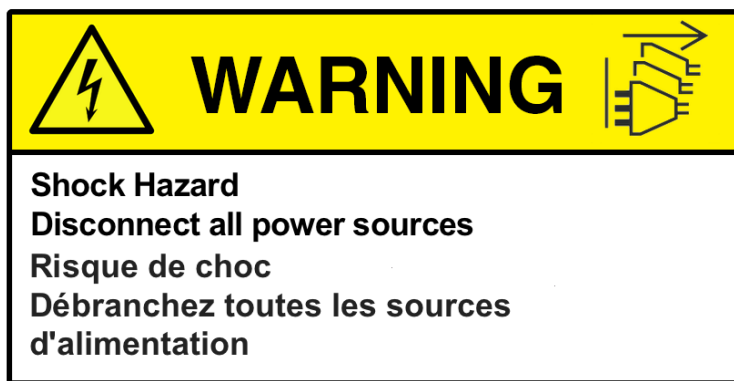

---

**Note**

Pluggable Equipment. The socket outlet shall be installed near the equipment and shall be easily accessible. ⚡ E5

---

---

**Note**

Refer to “Power Specifications” on page 195 for the power specifications of the switches.

---

3. Wait one minute for the switch to start the AlliedWare Plus software.  
The switch displays the number 1 on its ID LED and is now the master switch.
4. Power on the switch to be assigned ID number 2.
5. Wait two minutes for the new switch to join the stack as a member.

The new switch automatically boots up twice before joining the stack as a new member, once with the default ID number 1 and again with the next available number, which is 2.

6. If there is a third switch, power it on and wait two minutes for it to join the stack as a member with the ID number 3.
7. Repeat step 6 until all the switches are powered on.

The stack is now operational. The switches retain their ID numbers even when reset or powered off.

8. To continue with the installation, go to “Starting a Management Session” on page 138 and “Verifying the Stack” on page 143.

## Powering On the Switches Simultaneously

---

This procedure powers on the switches simultaneously. They assign their ID numbers automatically by performing the following steps:

1. They start the AlliedWare Plus software.
2. They compare their switch priority numbers over the stack trunk.
3. Since they all have the same priority number, the default 128, they compare MAC addresses.
4. The switch with the lowest MAC address becomes the master switch.
5. The master switch assigns itself the ID number 1.
6. The master switch assigns ID numbers to the other switches.
7. The other switches reboot the AlliedWare Plus software with their new ID numbers.

This procedure assumes the following:

- This is the first power on sequence of the stack.
- You cabled ports on the switches to form the stack trunk.
  - x530-10GHXm: SFP+ ports 9/S1 and 10/S2
  - x530-18GHXm: SFP+ ports 17/S1 and 18/S2
  - x530-28GTXm, x530-28GPXm or x530-28GSX: SFP+ ports 27/S1 and 28/S2
  - x530-52GTXm or x530-52GPXm: SFP+ ports 51/S1 and 52/S2

---

### Note

As explained in “Stack Trunks” on page 63, you can connect the same ports together (e.g., S1 to S1 and S2 to S2) or you can cross them over (e.g., S1 to S2 and S2 to S1). Allied Telesis recommends the latter.

---

- The ID numbers are set to the default 1.
- The switches are powered off.

To monitor the power-on sequence, you can connect a terminal or computer with a terminal emulator program to the Console port on any of the switches. For the terminal settings, refer to “Starting a Management Session” on page 138.

To have the switches automatically assign the ID numbers, perform the following procedure:

1. Cable the SFP+ ports S1 and S2 on the switches of the stack. For background information, refer to “Stack Trunks” on page 63, For cabling instructions, refer to Chapter 9, “Cabling the Networking Ports” on page 173.
2. Power on all the switches in the stack at the same time. Refer to “Powering on a Switch” on page 146.

---

**Note**

Refer to “Power Specifications” on page 195 for the power specifications of the switches.

---



---

**Warning**

Power cord is used as a disconnection device. To de-energize equipment, disconnect the power cord. ⚡ E3

---

---

**Note**

Pluggable Equipment. The socket outlet shall be installed near the equipment and shall be easily accessible. ⚡ E5

---

3. Wait three minutes for the switches to select the master switch and for the master switch to assign ID numbers to the member switches.

The stack is now operational. The switches retain their ID numbers when reset or powered off.

4. To continue with the installation, go to “Starting a Management Session” on page 138 and “Verifying the Stack” on page 143.

## Starting a Management Session

---

The following procedures explain the different methods for starting a management session on the switch:

- ❑ “Through the Console Port,” next
- ❑ “With a DHCP or DHCPv6 Server” on page 140
- ❑ “Without a DHCP or DHCPv6 Server” on page 141

### Through the Console Port

This section explains how to start a local management session through the Console port on the switch. This procedure requires a terminal, computer, or laptop with an RS-232 DB-9 serial port or USB port, and a terminal emulator, such as PuTTY. Here are the guidelines:

- ❑ Local management sessions require a management cable. If your computer has an RS-232 port, you may use the management cable supplied with the product, shown in Figure 52. The cable has a RJ-45 connector that connects to the Console port on the switch, and a female DB-9 (D-sub 9-pin) connector that connects to your computer.



Figure 52. Management Cable Included with Switch

- ❑ If your computer has a USB port, you may need to purchase a USB-to-Serial converter that is compatible with its operating system. An example is the VT-Kit3 converter from Allied Telesis, shown in Figure 53. The VT-Kit3 converter is sold separately.



Figure 53. VT-Kit3 Management Cable

- ❑ Local management sessions do not interfere with the network operations of the switch.

- ❑ The switch does not need an IP address for local management sessions.

To start a local management session, perform the following procedure:

1. Connect your computer to the Console port on the switch:
  - ❑ If your computer has an RS-232 port, connect the DB-9 connector on the supplied management cable to a DB-9 port on your computer or terminal, and the cable's RJ-45 connector to the Console port on the switch.
  - ❑ If your computer has a USB port, use a USB-to-Serial converter. To use the VT-Kit3 from Allied Telesis, connect the USB connector on the VT-Kit3 to a USB port on your computer or terminal. To connect the kit to the Console port on the switch, use a standard, straight-through Ethernet cable. Refer to Figure 54.

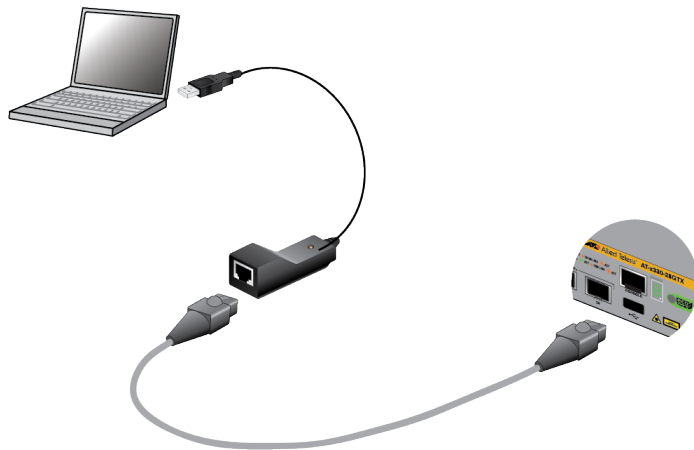

Figure 54. , VT-Kit3 Management Cable with Workstation and Switch

2. Configure the VT-100 terminal or terminal emulation program:
  - ❑ Baud rate: 9600 bps (The baud rate of the Console port is adjustable from 1200 to 115200 bps. The default is 9600 bps.)
  - ❑ Data bits: 8
  - ❑ Parity: None
  - ❑ Stop bits: 1
  - ❑ Flow controller: None

---

**Note**

The port settings are for a DEC VT100 or ANSI terminal, or an equivalent terminal emulator program.

---

---

**Note**

The baud rate must be set to the default 9600 bps to configure the boot loader.

---

3. Press Enter. You are prompted for the name and password of the manager account.
4. Enter the user name and password. The default values are “manager” and “friend” (without the quotes), respectively.

---

**Note**

User names and passwords are case sensitive.

---

The switch starts the local management session and displays the following prompt:

```
awplus>
```

The prompt identifies the User Exec mode of the command line interface.

5. Go to “Verifying the Stack” on page 143.

## **With a DHCP or DHCPv6 Server**

To start a management session on the switch over a network that has a DHCP or DHCPv6 server, perform the following procedure:

1. Connect a single Ethernet port on the switch to your existing network.
2. Power on the switch. Wait several minutes for it to finish loading the AlliedWare Plus software and obtain its IPv4 or IPv6 address from the existing DHCP server.
3. On your management workstation, enter the switch’s assigned IP address into a Secure Shell (SSH) application or the URL field of your web browser on your workstation.
4. Press Enter. You are prompted for the name and password of the manager account.
5. Enter the user name and password. The default values are “manager” and “friend” (without the quotes), respectively.

---

**Note**

User names and passwords are case sensitive.

---

The switch starts the local management session and displays the following prompt:



```
awplus>
```

The prompt identifies the User Exec mode of the command line interface.

6. Go to “Verifying the Stack” on page 143.

### **Without a DHCP or DHCPv6 Server**

To start a management session on the switch over a network without a DHCP or DHCPv6 server, perform the following procedure:

1. Change the IP address of your workstation to 169.254.42.*n*/16 (255.255.0.0), where *n* is any number from 1 to 254, but not 42.
2. Connect the Ethernet port on your workstation to an Ethernet port on the switch.
3. Power on the switch. Wait several minutes for it to finish loading the AlliedWare Plus software.
4. Enter the IP address 169.254.42.42, the switch’s default IP address, in an SSH application or the URL field of the web browser on your workstation.
5. Press Enter. You are prompted for the name and password of the manager account.
6. Enter the user name and password. The default values are “manager” and “friend” (without the quotes), respectively.

---

#### **Note**

User names and passwords are case sensitive.

---

The switch starts the local management session and displays the following prompt:

```
awplus>
```

The prompt identifies the User Exec mode of the command line interface.

7. Go to “Verifying the Stack” on page 143.
8. Configure the terminal or terminal emulator program as follows:
  - Default baud rate: 9,600 bps (range is 9,600 to 115,200 bps)
  - Data bits: 8
  - Parity: None
  - Stop bits: 1

- Flow control: None

---

**Note**

The port settings are for a DEC VT100 or ANSI terminal, or an equivalent terminal emulator program.

---

9. Press Enter.

You are prompted for a user name and password.

10. When prompted, type a user name and password to log on to the switch. If this is the initial management session, enter “manager” as the user name and “friend” as the password. The user name and password are case sensitive.

The local management session starts when the User Exec mode prompts:

```
awp1us>
```

---

**Note**

The User Exec mode is the first level in the command mode interface. For complete information on the modes and commands, refer to the *Command Reference: x530 Series Switches Running AlliedWare Plus Version 5.5.0* at [www.alliedtelesis.com/library](http://www.alliedtelesis.com/library).

---

11. Go to “Verifying the Stack” on page 143.

## Verifying the Stack

To verify the stack, perform the following procedure:

1. Start a local management session on any switch in the stack. Refer to “Starting a Management Session” on page 138.
2. From the User Exec mode, enter the SHOW STACK command:

```
awplus> show stack
```

An example of a stack of four switches is shown in Figure 55.

```
awplus> show stack
Virtual Chassis Stacking summary information
ID      Pending ID      MAC address      Priority      Status      Role
1       -                nnnn:nnnn:nnnn  128          Ready       Active Master
2       -                nnnn:nnnn:nnnn  128          Ready       Backup Member
3       -                nnnn:nnnn:nnnn  128          Ready       Backup Member
4       -                nnnn:nnnn:nnnn  128          Ready       Backup Member
Operational Status      Normal operations
Stack MAC address      nnnn:nnnn:nnnn
awplus(config)#
```

Figure 55. SHOW STACK Command

Consider the following:

- The command should list all switches in the stack. If the list is incomplete, refer to Chapter 10, “Troubleshooting” on page 183.
  - The Operational Status field displays “Normal operations” when the switches are connected in the ring topology and “Not all stack ports are up” when the switches are connected in the linear topology.
  - The priority values will be 128, the default value, if you did not change them.
  - There is no relationship between the ID numbers and the selection of the master switch. Consequently, the active master in the SHOW STACK command might not have the ID number 1.
3. Do one of the following:
    - To add one or two more SFP+ ports to the stack trunk, go to “Adding SFP+ Ports to the Stack Trunk” on page 144.
    - To change the priority values of the switches, go to “STACK PRIORITY Command” on page 151. The procedure is optional.
    - Otherwise, go to Chapter 9, “Cabling the Networking Ports” on page 173 to complete the installation.

## Adding SFP+ Ports to the Stack Trunk

This procedure explains how to add the following SFP+ ports to the stack trunk.

- ❑ SFP+ ports 25 to 26 on the 28-port x530-28GTXm, x530-28GPXm, or AT-x530-28GSX.
- ❑ SFP+ ports 49 to 50 on the 52-port x530-52GTXm and x530-52GPXm.

The procedure assumes the following:

- ❑ You performed the procedures earlier in this chapter to power on and verify the stack.
- ❑ The SFP+ ports you are adding to the trunk are not cabled. If there are cables connected to the ports, remove them before performing the procedure.

To add SFP+ ports to the stack trunk, perform the following procedure:

Table 23. Adding SFP+ Ports to the Default SFP+ Trunk

Step	Description and Command
1	Start a local management session on any switch in the stack. Refer to “Starting a Management Session” on page 138.
2	Move to the Privileged Exec mode with the ENABLE command.  awplus> enable
3	Move to the Global Configuration mode with the CONFIGURE TERMINAL command.  awplus# configure terminal Enter configuration commands, one per line. End with CNTL/Z.
4	Enter the port Interface modes of the SFP+ ports that you want to add to the trunk. This example assumes the stack has four switches. Switches with ID numbers 1 and 2 are 28-port units and switches with ID numbers 3 and 4 are 52-port units:  awplus(config)# interface port1.0.25-1.0.26,port2.0.25-2.0.26,port3.0.49-3.0.50,port4.0.49-4.0.50
5	Designate the ports as stacking ports with the STACKPORT command.  awplus(config-if)# stackport % Save the config and restart the system for this change to take effect.

Table 23. Adding SFP+ Ports to the Default SFP+ Trunk (Continued)

Step	Description and Command
6	Return to the Global Configuration mode. <code>awplus(config-if)# exit</code>
7	Return to the Privileged Exec mode. <code>awplus(config)# exit</code>
8	Enter the WRITE command to save your change. <code>awplus# write</code> Building configuration ... [OK]
9	Power off the switches of the stack.
10	Cable the new SFP+ ports on the trunk.
11	Power on the switches.
12	Wait three minutes for the switches to start the AlliedWare Plus software and form the stack.
13	Repeat “Verifying the Stack” on page 143.

## Powering on a Switch

Before powering on a switch, review the information in “Power Specifications” on page 195 for the power specifications of the switches.



### Warning

Power cord is used as a disconnection device. To de-energize equipment, disconnect the power cord. ⚡ E3

### Note

Pluggable Equipment. The socket outlet shall be installed near the equipment and shall be easily accessible. ⚡ E5

To power on a switch, perform the following procedure:

1. Install the power cord retaining clips on the AC power cords on the rear panel of the switch. Refer to Figure 56.

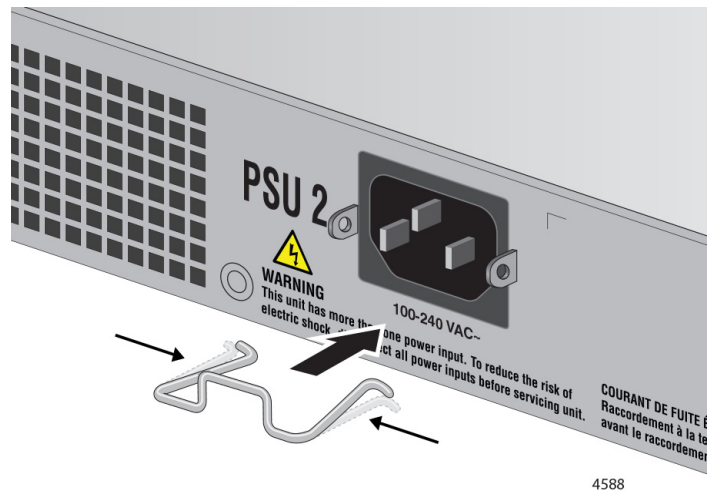

Figure 56. Installing the Power Cord Retaining Clips

2. Connect the AC power cords to the AC power connectors on the rear panel of the switch. Refer to Figure 57 on page 147.

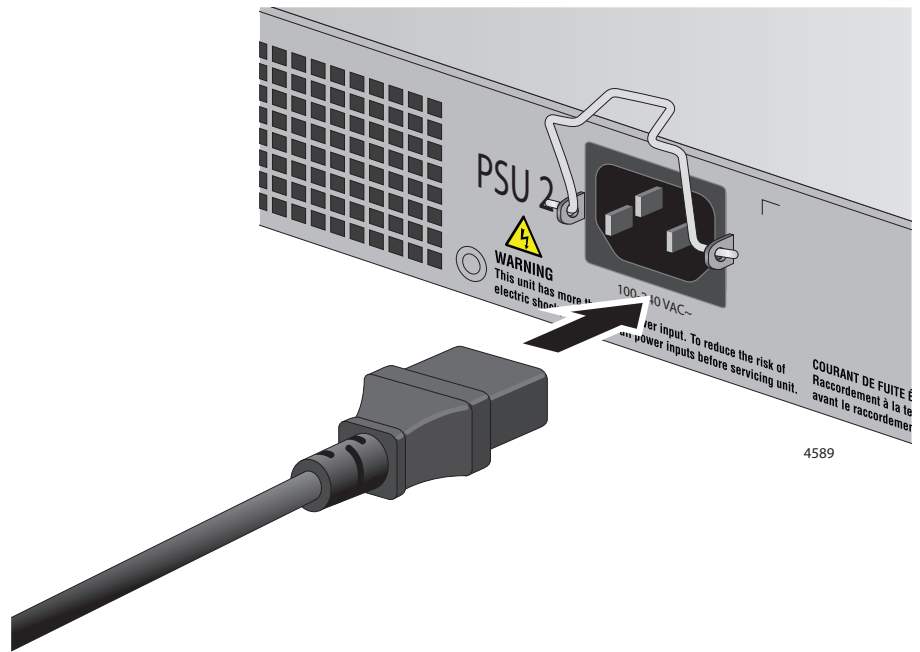

Figure 57. Connecting the AC Power Cord to the Switch

3. Lower the power cord retaining clips to secure the cord to the switch. Refer to Figure 58.

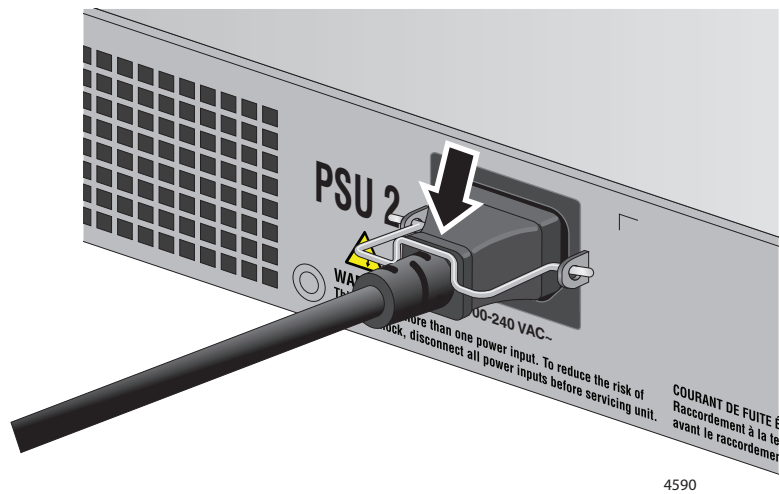

Figure 58. Plugging in the AC Power Cord to the Switch

4. Repeat steps 1 to 3 to connect a power cord to the second power supply.

5. Connect the power cords to appropriate AC power sources. Refer to Figure 59.
6. Repeat this procedure to connect the second power cord to the switch.

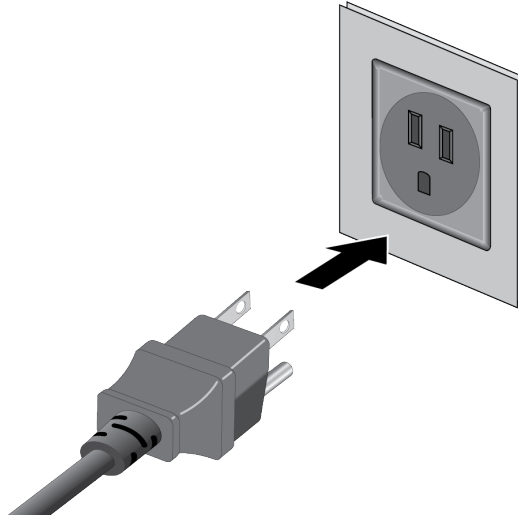

Figure 59. Plugging in the AC Power Cord to an AC Sources

7. Wait two minute for the switch to initialize its management software.



## Chapter 8

# Building the Stack with Gigabit or 5G Multi-speed Ports

---

This chapter explains how to build a stack of x530 Switches using the Gigabit Copper, Multi-speed Copper, or Gigabit SFP ports as the trunk. The chapter contains the following sections:

- ❑ “Introduction” on page 150
- ❑ “Command Summary” on page 151
- ❑ “Configuring the Master Switch” on page 154
- ❑ “Configuring Member Switches” on page 163
- ❑ “Powering on the Stack” on page 170
- ❑ “Verifying the Stack” on page 171

## Introduction

---

This chapter contains instructions on building a stack using the following ports as the trunk:

- ❑ Gigabit Copper ports
- ❑ 5G Multi-speed copper ports
- ❑ SFP Gigabit ports on the AT-x530-28GSX Switch

For further information, refer to “Stack Trunks of 5Gbps Copper Ports” on page 69.

Here are the general steps:

1. Fill in “Stacking Worksheet” on page 87.
2. Review “Command Summary” on page 151.
3. Perform “Configuring the Master Switch” on page 154.
4. Perform “Configuring Member Switches” on page 163.
5. Perform “Powering on the Stack” on page 170
6. Perform “Verifying the Stack” on page 171

Review the following information before performing the instructions:

- ❑ Perform the procedures in the order presented here.
- ❑ The master switch can be any x530 Switch. Refer to “Master and Member Switches” on page 78.
- ❑ If network cables are connected to the Gigabit ports that will be the trunk, disconnect them before continuing. You should configure the switches before cabling the trunk ports.

---

### **Note**

Cabling the ports of the stack trunk before configuring the switches can result in loops in your network topology, which can cause poor network performance.

---

## Command Summary

---

This section describes the AlliedWare Plus commands for configuring master and member switches to use Gigabit Copper, Multi-speed Copper or Gigabit SFP as the stack trunk. For further instructions, refer to the *Command Reference: x530 Series Switches Running AlliedWare Plus Version 5.5.0* at [www.alliedtelesis.com/library](http://www.alliedtelesis.com/library). After reviewing the commands, go to “Configuring the Master Switch” on page 154 to start the configuration procedures.

### **STACK ENABLE Command**

You use this command in the Global Configuration mode of the AlliedWare Plus software to enable and disable the VCStack feature on the switch. It has these formats:

- STACK ENABLE:** This command enables VCStack on the switch. This is the default.
- NO STACK <ID> ENABLE:** This command disables VCStack. You can use the switch as a standalone unit when the feature is disabled.

### **STACKPORT Command**

You use this command in the port interface modes of the AlliedWare Plus software to add and remove ports from the stack trunk. Here are its two forms:

- STACKPORT:** You use this command to add ports to the stack trunk.
- NO STACKPORT:** You use this command to remove ports from the stack trunk and return them to regular Ethernet networking ports.

### **STACK PRIORITY Command**

This command is used to set a switch’s priority value. Every switch in a stack has a priority value. The range is 0 to 255. The default is 128. The lower the number, the higher the priority. Switches use their priority settings for the following functions:

- Select the master switch when the switches are powered on or rebooted simultaneously.
- Designate the order in which they become the master switch if the active master switch stops responding. If the switches have the same priority value, they use their MAC addresses to select the master. The lower the MAC address, the higher the priority.

Allied Telesis recommends setting the priority numbers to match the switch ID numbers. For example, the switch with ID 1 should be assigned priority 1, switch with ID 2 should be assigned priority 2, and so on. This is not a requirement, but it can make managing and troubleshooting the stack easier.

You can set the priority number on the master switch before building the stack, but you have to wait until the member switches are part of the stack before setting their priority values.

---

**Note**

Setting the priority values can protect the stack's configuration if you later add a new switch that has a lower MAC address than the active master while the stack is powered off. If the priority values of the switches are at the default value when you power on the stack, the new switch might become the master, possibly resulting in the loss of the stack's configuration.

---

The command has this format:

```
stack switch_ID priority priority_number
```

The variables are defined here:

- ❑ `switch_ID` - This is the ID number of the switch. The ID number is displayed on the ID LED on the front panel. The range of this value depends on the type of trunk port. The range is 1 to 8 for stacks that use the SFP+ or 5G Multi-speed ports for the trunk. The range is 1 to 4 for stacks that use Gigabit copper ports or the Gigabit SFP ports on the x530-28GSX switch for the trunk.
- ❑ `priority_number` - This is the new priority number for the switch. The range is 0 to 255. The default is 128. You can specify only one number.

This example assigns the priority 1 to the switch with ID 1:

```
awplus(config)# stack 1 priority 1
```

This example assigns the priority 2 to the switch with ID 2:

```
awplus(config)# stack 2 priority 2
```

## STACK RENUMBER Command

Every switch in the stack must have a unique ID number. They display their numbers on the ID LEDs on the front panels. The range is 1 to 8 or 1 to 4, depending on the type of trunk ports. The default is 1. You use the numbers to identify switches in the command line interface of the AlliedWare Plus software. Refer to “Switch ID Numbers” on page 80.

The master switch can assign the ID numbers automatically during the first power-on of the stack, or you can use this command to set them either before or immediately after building the stack. The command, which is found in the Global Configuration mode, has this format:

```
stack current_switch_ID renumber new_switch_ID
```

The variables are defined here:

- ❑ *current\_switch\_ID* - This is the current ID number of the switch. You can specify only one ID number.
- ❑ *new\_switch\_ID* - This is the new ID number for the switch. The default is 1. You can specify only one number.

Changing the ID number requires resetting the switch.

This example changes a switch’s current ID from 1, the default, to 2:

```
awplus(config)# stack 1 renumber 2
```

---

### Note

Switches use their priority numbers and MAC addresses, not their ID numbers, to select the master switch. Consequently, the master switch of the stack might not have the ID number 1.

---

## SWITCH PROVISION Command

You use this command to add member switches to the configuration of the master switch before powering on the stack for the first time. Here is the format of the command:

```
switch switch_ID provision x530
```

This example adds a provisioned member switch with the ID 2 to the master switch:

```
awplus(config)# switch 2 provision x530
```

You can add one member switch at a time with the command.

## Configuring the Master Switch

---

This section contains the procedures for configuring x530 Switches to be the master switch of a stack. The procedures designate the Gigabit copper or 5G Multi-speed copper ports as the stack trunk. You can also use this procedure to designate the Gigabit SFP ports on the x530-28GSX switch as the trunk. This procedure also adds the member switches as provisioned switches to the configuration of the master switch.

---

**Note**

Any x530 Switch can be the master switch of the stack.

---

Here are the procedures:

- “General Steps for the Master Switch,” next
- “Configuring the Master Switch - Part I” on page 156
- “Configuring the Master Switch - Part II” on page 158
- “Verifying the Master Switch” on page 160
- “What to Do Next” on page 162

The procedures should be performed in the order presented here.

---

**Note**

The procedures require resetting the switch. Some network traffic will be lost if its ports are connected to active networks.

---

Allied Telesis recommends filling out the “Stacking Worksheet” on page 87 before building the stack.

## General Steps for the Master Switch

There are two parts to configuring the master switch to use copper, Multi-speed 5G, or Gigabit SFP as the stack trunk. Here are the main steps to Part I:

1. Start a local management session on the switch.
2. Remove the SFP+ S1 and S2 ports as the default trunk ports on the switch with the NO STACKPORT command.
3. Designate the trunk ports of to be the stack trunk with the STACKPORT command in the port interface modes.
4. Assign the master switch the priority 1 with the STACK PRIORITY command in the Global Configuration mode to designate it as master switch of the stack. This step is optional.
5. Save the changes with the WRITE command in the Privileged Exec mode.

Here are the main steps to Part II:

1. Add the member switches as provisioned units to the configuration of the master switch, with the SWITCH PROVISION command.
2. Designate up to eight Gigabit ports on the provisioned member switches with the STACKPORT command in the port interface modes.
3. Save your changes to the master switch with the WRITE command in the Privilege Exec mode.
4. Reboot the master switch with the REBOOT command.
5. Start a new local management session.
6. Verify the changes on the master switch with the SHOW STACK and SHOW RUNNING-CONFIG INTERFACE command.

**Configuring the Master Switch - Part I** To designate the trunk ports on the master switch, start by performing the procedure in Table 24.

Table 24. Configuring the Master Switch to Use Gigabit or Multi-speed 5G Ports as the Stack Trunk - Part I

Step	Description and Command
1	Power on the switch to be the master switch and start a local management session. Any x530 Switch can be the master switch of a stack. Refer to “Starting a Management Session” on page 138.
2	Enter the ENABLE and CONFIGURE TERMINAL commands to move to the Global Configuration mode.  <pre>awplus&gt; enable awplus# configure terminal</pre> Enter configuration commands, one per line. End with CNTL/Z. <pre>awplus(config)#</pre>
Steps 3 and 4 remove SFP+ S1 and S2 ports as the default trunk ports. You can use the ports as regular networking ports.	
3	Enter the Interface modes for the default SFP+ S1 and S2 trunk ports on the master switch. The default trunk ports are the two highest numbered ports on the switches. This example assumes that the switch is a 28-port switch:  <pre>awplus(config)# interface port1.0.27-1.0.28 % port1.0.27 is currently configured as a stack-port. Use caution when altering its config. % port1.0.28 is currently configured as a stack-port. Use caution when altering its config.</pre>
4	Remove the ports as trunk ports and convert them into regular Ethernet ports with the NO STACKPORT command:  <pre>awplus(config-if)# no stackport % Save the config and restart the system for this change to take effect.</pre>



Table 24. Configuring the Master Switch to Use Gigabit or Multi-speed 5G Ports as the Stack Trunk - Part I (Continued)

Step	Description and Command
Steps 5 and 6 designate the copper Gigabit, copper Multi-speed 5G, or Gigabit SFP ports of the trunk.	
5	Enter the port interface modes of the ports to be the stack trunk. If you filled out the Stack Worksheet, refer there for the ports. This example assumes ports 1 to 8 will be the trunk:  <pre>awplus(config)# interface port1.0.1-1.0.8 awplus(config-if)#</pre>
6	Enter the STACKPORT command to designate the selected Gigabit ports as the stack trunk:  <pre>awplus(config-if)# stackport</pre> % Save the config and restart the system for this change to take effect.
Steps 7 and 8 assign the switch the priority 1 with the STACK PRIORITY command to designate it as the master unit of the stack. These steps are optional.	
7	Enter the EXIT command to return to the Global Configuration mode.  <pre>awplus(config-if)# exit</pre>
8	Enter the STACK PRIORITY command to assign priority 1 to the switch.  <pre>awplus(config)# stack 1 priority 1</pre>
The remaining steps save your changes.	
9	Enter the EXIT command to return to the Privileged Exec mode.  <pre>awplus(config)# exit</pre>
10	Enter the WRITE command to save your changes.  <pre>awplus# write Building configuration ... [OK]</pre>
11	Go to “Configuring the Master Switch - Part II,” next.

## Configuring the Master Switch - Part II

In Part II you add the member switches to the configuration of the master switch and designate their trunk ports. This is referred to as provisioning the master switch. The procedure assumes you are continuing directly from the previous procedure.

Table 25. Configuring the Master Switch to Use Gigabit or 5G Multi-speed Ports as the Stack Trunk - Part II

Step	Description and Command
Steps 1 to 2 add the member switches as provisioned switches to the master switch.	
1	<p>Enter the CONFIGURE TERMINAL command to move to the Global Configuration mode.</p> <pre>awplus# configure terminal Enter configuration commands, one per line. End with CNTL/Z. awplus(config)#</pre>
2	<p>Enter the SWITCH PROVISION command to add the member switches as provisioned switches to the configuration of the master switch. (A stack with a trunk of copper Gigabit or SFP can have up to four switches. A stack with a trunk of 5G Multi-speed ports can have up to eight switches.) Assign each unit a unique ID number. These examples add two 28-port switches and one 52-port switch as provisioned member switches to the master switch, with the IDs 2 to 4:</p> <pre>awplus(config)# switch 2 provision x530-28 awplus(config)# switch 3 provision x530-28 awplus(config)# switch 4 provision x530-52</pre>
Steps 3 and 4 remove SFP+ S1 and S2 ports as the default trunk ports on the provisioned member switches. This enables the ports to function as regular networking ports.	
3	<p>Enter the port Interface modes of the default SFP+ S1 and S2 trunk ports on the provisioned member switches. The default trunk ports are the two highest numbered ports on the switches. This example assumes three provisioned member switches, with the IDs 2 to 4. It also assumes that two member switches are 28-port units and one is a 52-port unit.</p> <pre>awplus(config)# interface port2.0.27-2.0.28,port3.0.27-3.0.28, port4.0.51-4.0.52</pre>
4	<p>Remove the ports on the provisioned switches as trunk ports and convert them into regular Ethernet ports with the NO STACKPORT command:</p> <pre>awplus(config-if)# no stackport % Save the config and restart the system for this change to take effect.</pre>
Steps 5 and 6 designate the Gigabit, 5G Multi-speed, or Gigabit SFP ports that will be the trunk ports on the member switches.	

Table 25. Configuring the Master Switch to Use Gigabit or 5G Multi-speed Ports as the Stack Trunk - Part II (Continued)

Step	Description and Command
5	<p>Enter the port interface modes of the ports provisioned on the member switches to be the stack trunk. The trunk can have up to eight ports per switch. If you filled out the Stack Worksheet, refer there for the ports. This example assumes the member switches will use ports 1 to 8 as the stack trunk:</p> <pre>awplus(config)# interface port2.0.1-2.0.8,port3.0.1-3.0.8,port4.0.1-4.0.8 awplus(config-if)#</pre>
6	<p>Enter the STACKPORT command to designate the selected as the stack trunk:</p> <pre>awplus(config-if)# stackport</pre> <p>% Save the config and restart the system for this change to take effect.</p>
The remaining steps save your changes and reboot the master switch.	
7	<p>Enter the EXIT command twice to return to the Privileged Exec mode.</p> <pre>awplus(config-if)# exit awplus(config)# exit</pre>
8	<p>Enter the WRITE command to save your changes.</p> <pre>awplus# write Building configuration ... [OK]</pre>
9	<p>Restart the switch with the REBOOT command.</p> <pre>awplus# reboot reboot system? (y/n):</pre>
10	Type "Y" for yes.
11	Wait one minute for the switch to start the AlliedWare Plus software.
12	Go to "Verifying the Master Switch" on page 160.

## Verifying the Master Switch

To confirm the configuration of the master switch, perform the following steps:

1. Start a new local management session on the master switch. Refer to “Starting a Management Session” on page 138.
2. Move to the Privileged Exec mode with the ENABLE command.  

```
awplus> enable
awplus#
```
3. Enter the SHOW STACK command. Figure 60 is an example of a master switch with three provisioned member switches:

```
awplus# show stack
Virtual Chassis Stacking summary information
ID Pending ID  MAC address          Priority  Status  Role
1  -             nnnn.nnnn.nnnn      1        Ready   Active Master
2  -             -                   -         -       Provisioned
3  -             -                   -         -       Provisioned
4  -             -                   -         -       Provisioned
Operational Status          Standalone unit
Stack MAC address           nnnn.nnnn.nnnn
```

Figure 60. SHOW STACK Command on the Master Switch

4. Check the display for the following:
  - Switch ID 1 is the master switch.
  - The other ID entries are the provisioned member switches. There should be one entry for each member switch that will be in the stack. If the table does not include these fields, perform the SWITCH PROVISION command in “Configuring the Master Switch - Part II” on page 158.
  - The master switch should have the priority 1 if you performed the STACK PRIORITY command in “Configuring the Master Switch - Part I” on page 156.
5. Enter the SHOW RUNNING-CONFIG INTERFACE command to view the port configurations on the master switch and provisioned member switches. Use the display to confirm that the correct ports have the STACKPORT command, designating them as the stack trunk:

```
awplus# show running-config interface
interface port1.0.1-1.0.23
  switchport
  switchport mode access

stack enable front-panel-ports
!
interface port1.0.1-1.0.8  Trunk ports on the
  stackport                master switch
!
interface port1.0.27-1.0.28
  switchport
  switchport mode access
!
interface port2.0.1-2.0.23
  switchport
  switchport mode access
!
interface port2.0.1-2.0.8  Trunk ports on a
  stackport                provisioned member
                          switch
!
interface port2.0.27-2.0.28
  switchport
  switchport mode access
.
.
```

Figure 61. SHOW RUNNING-CONFIG INTERFACE Command on the Master Switch

6. Go to “What to Do Next,” next.

**What to Do Next** After configuring the master switch, do the following:

1. Power off the switch by disconnecting its AC power cords from the AC power sources. Refer to Figure 62.

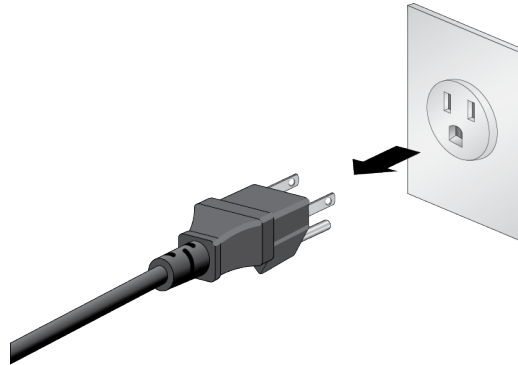

Figure 62. Powering Off the Switch

2. Configure the member switches. Refer to “Configuring Member Switches” on page 163.
3. After configuring the master and member switches, cable the ports of the stack trunk on all switches. Refer to “Cabling Copper Ports” on page 174 or “Installing SFP and SFP+ Transceivers” on page 176.
4. Power on the master and member switches of the stack. Refer to “Powering on the Stack” on page 170.
5. Verify that the switches formed the stack by performing to “Verifying the Stack” on page 171.
6. Cable the networking ports. Refer to Chapter 9, “Cabling the Networking Ports” on page 173.

## Configuring Member Switches

---

This section contains the procedures for configuring member switches of the stack by assigning them ID numbers and designating the copper Gigabit, copper 5G Multi-speed, or Gigabit SFP ports of the stack trunk: Here are the procedures:

- ❑ “General Steps for the Member Switch,” next
- ❑ “Configuring Member Switches - Part I” on page 164
- ❑ “Configuring Member Switches - Part II” on page 165
- ❑ “Verifying Member Switches” on page 167
- ❑ “What to Do Next” on page 169

You have to perform the procedures on each member switch individually, before connecting the trunk ports. The procedures should be performed in the order presented here.

---

### Note

The procedures require resetting member switches. Some network traffic will be lost if the ports are connected to an active network.

---

### General Steps for the Member Switch

Configuring the member switches has two parts. Part I has these main steps:

1. Start a local management session on the switch.
2. Assign an ID number to the member switch with the SWITCH RENUMBER command in the Global Configuration mode. The range is 2 to 4 for stacks with trunks of Gigabit ports and 2 to 8 for stacks with trunks of 5G Multi-speed ports.
3. Save your changes with the WRITE command in the Privilege Exec mode.
4. Restart the switch with the REBOOT command.

Part II has these main steps:

1. Start a new local management session with the switch.
2. Remove the SFP+ S1 and S2 ports as the default trunk ports on the member switch with the NO STACKPORT command.
3. Designate the ports of the stack trunk with the STACKPORT command in the port interface modes.

4. Save your changes with the WRITE command in the Privilege Exec mode.
5. Restart the switch with the REBOOT command.
6. Start a new local management session.
7. Verify your changes with the SHOW STACK and SHOW RUNNING-CONFIG INTERFACE commands.

**Configuring Member Switches - Part I**

Perform Part I in Table 26 to configure a member switch.

Table 26. Configuring Member Switches - Part I

Step	Description and Command
1	Power on a member switch and start a local management session. Refer to “Starting a Management Session” on page 138.
2	Enter the ENABLE and CONFIGURE TERMINAL commands to move to the Global Configuration mode:  <pre>awplus&gt; enable awplus# configure terminal</pre> Enter configuration commands, one per line. End with CNTL/Z. <pre>awplus(config)#</pre>
Step 3 sets the member switch’s ID number.	
3	Set the ID number of the member switch with the STACK RENUMBER command. Each switch must have a unique ID number. The default value is 1. If you are using the worksheet on “Stacking Worksheet” on page 87, refer there for the ID numbers. This example changes the switch’s ID number from the default value 1 to the new value 2.  <pre>awplus(config)# stack 1 renumber 2 % warning: the new ID will not become effective until the stack-member reboots. % warning: the boot configuration may now be invalid.</pre>
The remaining steps reboot the unit. (You do not have to update the configuration file with the WRITE command after changing a switch’s ID number.)	
4	Enter the EXIT command to return to the Privileged Exec mode.  <pre>awplus(config)# exit</pre>



Table 26. Configuring Member Switches - Part I (Continued)

Step	Description and Command
5	Restart the switch with the REBOOT command.  awplus# reboot reboot system? (y/n): awplus#
6	Type "Y" for yes.
7	Wait one minute for the switch to start the AlliedWare Plus software.
8	Check the ID LED on the front panel. Do one of the following: - If the ID LED is displaying the switch's new ID number, go to "Configuring Member Switches - Part II," next. - If the ID LED is displaying the wrong number, repeat this procedure.

### Configuring Member Switches - Part II

Part II has these actions:

- Remove the SFP+ S1 and S2 ports as the default trunk ports with the NO STACKPORT command.
- Designate the copper Gigabit, copper 5G Multi-speed, or Gigabit SFP ports of the trunk with the STACKPORT command in the port interface modes.
- Save your changes and reboot the switch.

Perform the procedure in Table 27.

Table 27. Configuring Member Switches - Part II

Step	Description and Command
1	Start a new local management session on the member switch. Refer to "Starting a Management Session" on page 138.
2	Enter the ENABLE and CONFIGURE TERMINAL commands to move to the Global Configuration mode.  awplus> enable awplus# configure terminal Enter configuration commands, one per line. End with CNTL/Z. awplus(config)#
Steps 3 and 4 remove SFP+ S1 and S2 ports as the default trunk ports, allowing the ports to function as regular networking ports.	

Table 27. Configuring Member Switches - Part II (Continued)

Step	Description and Command
3	<p>Enter the Interface modes for the SFP+ S1 and S2 ports on the member switch. They are the two highest numbered ports on the switch. This example assumes that the switch has the ID number 2 and is a 28-port switch. Remember to change the switch ID number in the PORT parameter as you configure each member switch:</p> <pre>awplus(config)# interface port2.0.27-2.0.28 % port2.0.27 is currently configured as a stack-port. Use caution when altering its config. % port2.0.28 is currently configured as a stack-port. Use caution when altering its config.</pre>
4	<p>Remove the ports as trunk ports and designate them as regular Ethernet ports with the NO STACKPORT command:</p> <pre>awplus(config-if)# no stackport % Save the config and restart the system for this change to take effect.</pre>
<p>Steps 5 and 6 designate the copper Gigabit, copper 5G Multi-speed, or Gigabit SFP ports of the trunk on the member switch.</p>	
5	<p>Enter the port Interface modes of the ports that are to be the trunk on the member switch. This example assumes the member switch has the ID 2 and the trunk will have ports 1 to 8. Remember to change the switch ID number in the PORT parameter as you configure each member switch:</p> <pre>awplus(config)# interface port2.0.1-2.0.8 awplus(config-if)#</pre>
6	<p>Designate the ports as the stack trunk with the STACKPORT command.</p> <pre>awplus(config-if)# stackport % Save the config and restart the system for this change to take effect.</pre>
<p>The remaining steps save your changes and reboot the switch.</p>	
7	<p>Enter the EXIT command twice to return to the Privilege Exec mode.</p> <pre>awplus(config-if)# exit awplus(config)# exit awplus#</pre>
8	<p>Save your changes with the WRITE command.</p> <pre>awplus# write Building configuration ... [OK]</pre>

Table 27. Configuring Member Switches - Part II (Continued)

Step	Description and Command
9	Reboot the switch.  awplus# reboot reboot system? (y/n):
10	Type "Y" for yes.
11	Wait one minute for the switch to start the AlliedWare Plus software.
12	Go to "Verifying Member Switches," next.

### Verifying Member Switches

Perform this procedure to verify the configuration of a member switch.

1. Start a new local management session on the switch. Refer to "Starting a Management Session" on page 138.
2. Move to the Privileged Exec mode with the ENABLE command.

```
awplus> enable
awplus#
```

3. Enter the SHOW STACK command. Figure 63 is an example of a member switch with the ID number 2.:

```
awplus# show stack
Virtual Chassis Stacking summary information
ID Pending ID  MAC address          Priority  Status  Role
1  -             -                    128     -       Provisioned
2  -             nnnn.nnnn.nnnn      128     Ready   Active Master
Operational Status          Standalone unit
Stack MAC address           nnnn.nnnn.nnnn
```

Figure 63. SHOW STACK Command for a Member Switch

4. Check the display for the following:
  - The values for the ID 1 row should be blank. This default provisioned entry will be used by the master switch when you power on the stack.
  - The member's Switch ID should be the number you assigned it in Part I.

5. Enter the `SHOW RUNNING-CONFIG INTERFACE` command to display the port configuration on the member switch. Confirm that the correct copper Gigabit, copper 5G Multi-speed, or Gigabit SFP ports on the member switch have the `STACKPORT` command, designating them as the trunk. Refer to Figure 64 for an example.

```

awplus# show running-config interface
interface port1.0.1-1.0.26
  switchport
  switchport mode access
!
stack enable front-panel-ports
!
interface port1.0.27-1.0.28 1
  stackport
!
interface port2.0.1-2.0.24
  switchport
  switchport mode access
!
interface port2.0.1-2.0.8 2
  stackport
!
interface port2.0.27-2.0.28
  switchport
  switchport mode access
!
awplus#

```

Figure 64. `SHOW RUNNING-CONFIG INTERFACE` Command for Member Switches

Note the following:

- ❑ 1 - These lines designate the stack ports for the default provisioned switch. You can ignore these lines on member switches.
- ❑ 2 - These lines designate the trunk ports for the member switch you are configuring. The switch ID number in the `PORT` parameter should match the ID number of the switch and the port numbers should be the ports of the trunk. Repeat the procedure if the display does not include these lines.

6. Go to “What to Do Next” on page 169.

**What to Do Next** After configuring a member switch, do the following:

1. Power off the member switch.
2. Repeat these procedures to configure all member switches, assigning each one a unique ID number and identifying the ports of the trunk.
3. If you have not already configured the master switch, perform “Configuring the Master Switch” on page 154.
4. Power off the master and all member switches.
5. Cable the ports of the trunk on the master and member switches. Refer to “Cabling Copper Ports” on page 174. For trunks consisting of Gigabit SFP ports on x530-28GSX Switches, refer to “Installing SFP and SFP+ Transceivers” on page 176. For cabling examples, refer to “Stack Trunks of 1Gbps Copper Ports” on page 72.
6. Perform “Powering on the Stack” on page 170.
7. Perform “Verifying the Stack” on page 171 to confirm that the switches formed the stack.
8. Cable the networking ports, as explained in Chapter 8, “Building the Stack with Gigabit or 5G Multi-speed Ports” on page 149.

## Powering on the Stack

---

After configuring the master and member switches for copper Gigabit, copper 5G Multi-speed, or Gigabit SFP ports as the trunk, you are ready to cable the trunk ports and power on the stack. You can monitor the power-on sequence by connecting a terminal or computer with a terminal emulator program to the Console port on the master switch. The terminal settings are listed in “Starting a Management Session” on page 138.

To power on the stack for the first time, perform the following procedure:

1. Verify that the master and member switches are powered off.
2. Cable the ports of the stack trunk on the switches. Refer to “Cabling Copper Ports” on page 174 or “Installing SFP and SFP+ Transceivers” on page 176 for trunks containing Gigabit SFP ports on x530-28GSX Switches. For cabling examples, refer to “Stack Trunks of 1Gbps Copper Ports” on page 72.
3. Power on the master switch.

Refer to “Power Specifications” on page 195 for the power specifications of the switches.



### Warning

Power cord is used as a disconnection device. To de-energize equipment, disconnect the power cord. *ES* E3

---

### Note

Pluggable Equipment. The socket outlet shall be installed near the equipment and shall be easily accessible. *ES* E5

---

4. Wait one minute for the master switch to start the AlliedWare Plus software.
5. Power on the member switches either sequentially or simultaneously.
6. Wait one minute for the member switches to join the stack.
7. Go to “Verifying the Stack” on page 171.

## Verifying the Stack

---

To verify the stack, perform the following procedure:

1. Start a local management session on any switch in the stack. Refer to “Starting a Management Session” on page 138.
2. From the User Exec mode, type the SHOW STACK command:

```
awplus> show stack
```

The following example is from a stack of three switches:

```
awplus> show stack
Virtual Chassis Stacking summary information
ID      Pending ID      MAC address      Priority      Status      Role
1       -                e01a:ea20:8011  1            Ready      Active Master
2       -                e01a:ea20:8012  2            Ready      Member
3       -                e01a:ea20:8902  3            Ready      Member
Operational Status      Normal operations
```

Review the following items:

- The command should list all the switches. If the list is incomplete, refer to Chapter 10, “Troubleshooting” on page 183.
  - The Operational Status field should be “Normal operations” to indicate that all the stacking ports are operating normally.
  - If the Operational Status field is displaying “Not all stack ports are up,” one or more stacking ports are not being used or cannot establish links with their counterparts. For more information, refer to Chapter 10, “Troubleshooting” on page 183.
3. Go to Chapter 9, “Cabling the Networking Ports” on page 173, to complete the installation.





## Chapter 9

# Cabling the Networking Ports

---

This chapter contains the following procedures:

- ❑ “Cabling Copper Ports” on page 174
- ❑ “Installing SFP and SFP+ Transceivers” on page 176
- ❑ “Installing SP10TW Direct Connect Cables” on page 180

## Cabling Copper Ports

---

Here are the guidelines to cabling the copper ports:

- ❑ The minimum copper cable requirements are as follows:
  - 10/100Mbps ports: Standard TIA/EIA 568-B-compliant Category 3 unshielded cabling.
  - 1/2.5/5Gbps ports: Standard TIA/EIA 568-A-compliant Category 5 or TIA/EIA 568-B-compliant Enhanced Category 5 (Cat 5e) unshielded cabling.
  - 10Gbps ports: Standard TIA/EIA 568-C-compliant Category 6a unshielded cabling.
- ❑ The cable specifications for the 10/100/1000Base-T copper ports are listed in “Cable Requirements” on page 34.
- ❑ The connectors on the cables should fit snugly into the ports, and the tabs should lock the connectors into place.
- ❑ The default setting for the wiring configurations of the ports is auto-MDI/MDI-X. The default setting is appropriate for switch ports that are connected to 10/100Base-TX network devices that also support auto-MDI/MDI-X.
- ❑ The default auto-MDI/MDI-X setting is not appropriate for switch ports that are connected to 10/100Base-TX network devices that do not support auto-MDI/MDI-X and have a fixed wiring configuration. For switch ports connected to those types of network devices, you should disable auto-MDI/MDI-X and set the wiring configurations manually.
- ❑ The appropriate MDI/MDI-X setting for a switch port connected to a 10/100Base-TX network device with a fixed wiring configuration depends on the setting of the network device and whether the switch and network device are connected with straight-through or crossover cable. If you are using straight-through twisted pair cable, the wiring configurations of a port on the switch and a port on a network device must be opposite each other, such that one port uses MDI and the other MDI-X. For example, if a network device has a fixed wiring configuration of MDI, you must disable auto-MDI/MDI-X on the corresponding switch port and manually set it to MDI-X. If you are using crossover twisted pair cable, the wiring configurations of a port on the switch and a port on a network device must be the same.
- ❑ PoE is enabled by default on the x530-10GHXm, x530-18GHXm, x530-28GPXm and x530-52GPXm switch ports.
- ❑ The connectors on the cables must fit snugly into the ports, and the tabs must lock the connectors into place.
- ❑ The default speed setting for the wiring configurations of the ports

is Auto-Negotiation. This setting is appropriate for ports connected to network devices that also support Auto-Negotiation.

- ❑ The ports must be set to the default setting of Auto-Negotiation to operate at 1000Gbps.
- ❑ The copper ports can operate in either half- or full-duplex mode when operating at 10/100Mbps. However, if any of the copper ports operate at 1000Mbps or higher, then the duplex mode is always full-duplex.
- ❑ Do not attach cables to ports of static or Link Aggregation Control Protocol (LACP) port trunks until after you configure the trunks on the switch. Otherwise, the ports will form network loops that can adversely affect network performance.

**Caution**

Disable PoE on ports before connecting or disconnecting copper cables to prevent damaging the switch. Disconnecting Ethernet copper network cables while the switch is providing power to powered devices (PDs) can damage the switch. *⚡* **E131**

---

## Installing SFP and SFP+ Transceivers

---

This section contains instructions for installing SFP and SFP+ transceivers in the ports on the switch. Please review this information before installing transceivers:

- ❑ Ports 1 to 24 on the x530-28GSX Switch support 100/1000Mbps SFP transceivers only. They do not support 10Gbps SFP+ transceivers.
- ❑ Ports 25 to 28 on 28-port switches and ports 49 to 52 on 52-port switches support 1000Mbps SFP and 10Gbps SFP+ transceivers. They do not support SFP 100Mbps transceivers.
- ❑ Ports 9 and 10 on the x530-10GHXm Switch and ports 17 and 18 on the x530-18GHXm Switch support 1000Mbps SFP and 10Gbps SFP+ transceivers. They do not support 100Mbps SFP transceivers.

---

**Note**

list of supported transceivers.

---

Review the following guidelines before installing SFP or SFP+ transceivers:

- ❑ SFP and SFP+ transceivers are hot-swappable. You can install them while the switch is powered on.

---

**Note**

For a list of supported transceivers, refer to the product data sheet on the Allied Telesis web site.

---

- ❑ The operational specifications and fiber optic cable requirements of the transceivers are provided in the documents included with the devices.
- ❑ Install a transceiver before connecting the fiber optic cable.
- ❑ Fiber optic transceivers are dust sensitive. Always keep the plug in the optical bores when a fiber optic cable is not installed, or when you store the transceiver. When you do remove the plug, keep it for future use.
- ❑ Unnecessary removal and insertion of a transceiver can lead to premature failure.



### Caution

Transceivers can be damaged by static electricity. Be sure to observe all standard electrostatic discharge (ESD) precautions, such as wearing an antistatic wrist strap, to avoid damaging the devices. *ES* E92

The illustrations in the procedure show a transceiver being installed in port 25 of a 28-port switch. The procedure is the same for all SFP and SFP+ ports.

To install transceivers, perform the following procedure:

1. If the transceiver port has a dust plug, remove it. Refer to Figure 65.

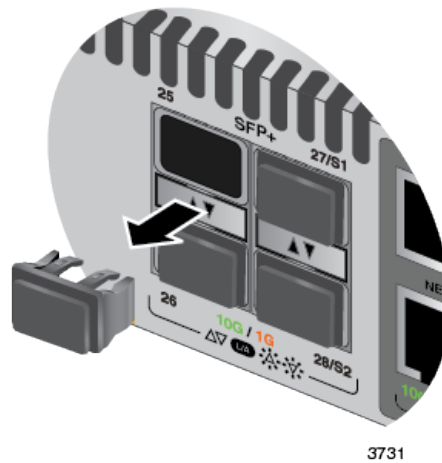

Figure 65. Removing the Dust Plug from an SFP+ Port

2. Remove the transceiver from its shipping container and store the packaging material in a safe location.
3. If you are installing the transceiver in a top port, position the transceiver with the Allied Telesis label facing up. If you are installing the transceiver in a bottom port, position the transceiver with the label facing down.
4. Slide the transceiver into the port until it clicks into place, as shown in Figure 66 on page 178.

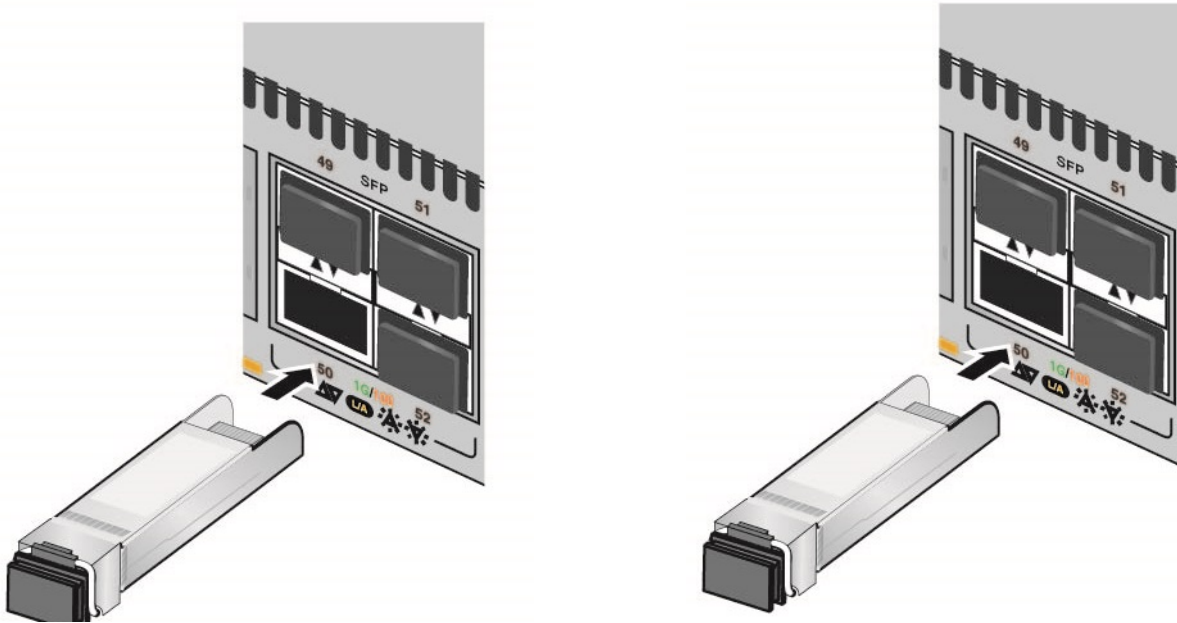

Figure 66. Installing SFP+ Transceivers

**Note**

If you are ready to attach the fiber optic cable to the transceiver, continue with the next step. Otherwise, repeat steps 1 to 4 to install the remaining transceivers in the switch.

5. Remove the dust cover from the transceiver. Refer to Figure 67.

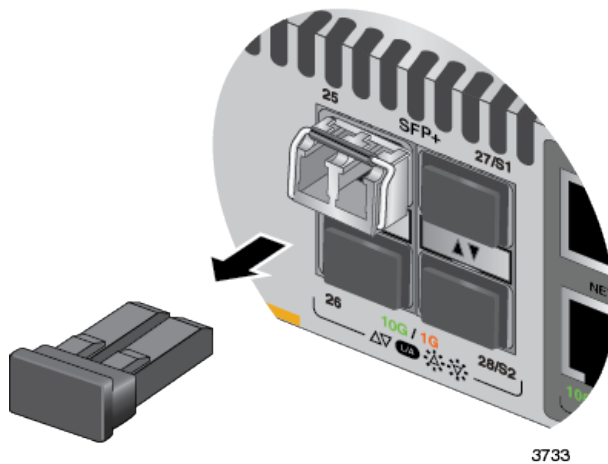

Figure 67. Removing the Dust Cover from an SFP or SFP+ Transceiver

- Verify the position of the handle on the transceiver. If the transceiver is in a top slot, the handle should be in the upright position, as shown in Figure 68. If the transceiver is in a bottom slot, the handle should be in the down position.

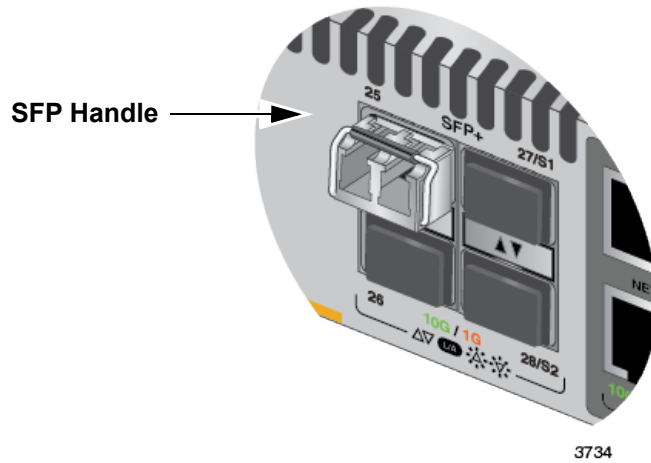

Figure 68. Positioning the SFP or SFP+ Handle in the Upright Position

- Connect the fiber optic cable to the transceiver, as shown in Figure 69 on page 179. The connector on the cable should fit snugly into the port, and the tab should lock the connector into place.

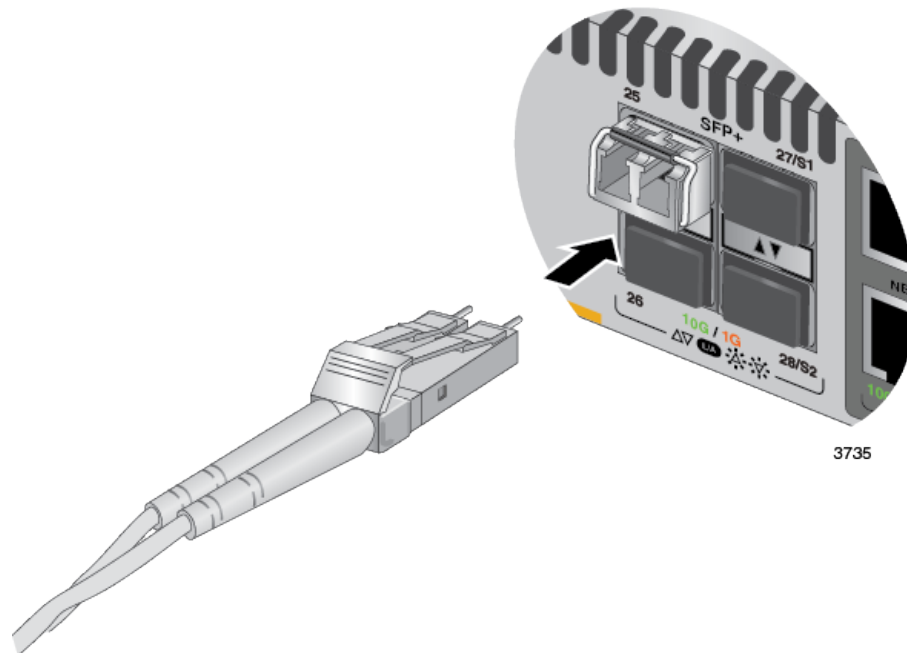

Figure 69. Connecting a Fiber Optic Cable to an SFP or SFP+ Transceiver

- Repeat this procedure to install and cable additional transceivers.

## Installing SP10TW Direct Connect Cables

---

The following SFP+ transceiver ports of the switches support SP10TW direct connect twinax cables:

- ❑ Ports 9 and 10 of the x530-10GHXm
- ❑ Ports 17 and 18 of the x530-18GHXm
- ❑ Ports 25 to 28 of the x530-28GTXm, x530-28GPXm and x530-28GSX
- ❑ Ports 49 to 52 of the x530-52GTXm and x530-52GPXm

The cables are an economical way to add 10Gbps connections over short distances. They have SFP+ transceivers on both ends and come in lengths of 1 and 3 meters.

To install AT-SP10TW direct connect cables, perform the following procedure:

1. If the SFP+ port has a dust cover, remove it. Refer to Figure 67 on page 178.
2. Remove the AT-SP10TW direct connect cable from its shipping container and store the packaging material in a safe location.
3. Remove the dust cap from a connector on the cable. Refer to Figure 70.

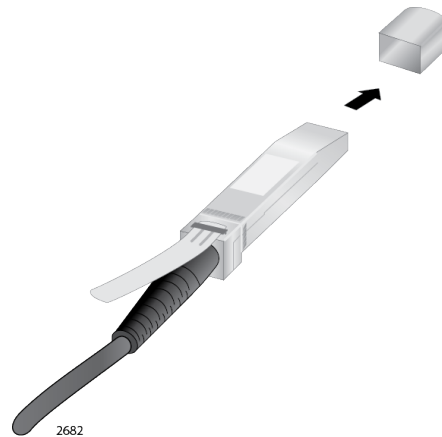

Figure 70. Removing the Dust Cover from the AT-SP10TW Cable

4. Slide the connector into the slot. The release tab on the connector must be on top if you are installing it in slot S1 or on the bottom if you are installing it in slot S2. Refer to Figure 71 on page 181.





Figure 71. Installing AT-SP10TW Cables

5. Repeat this procedure to install the other end of the cable into a port on another switch.

---

**Note**

To remove the connector and cable from the port, gently push on the connector, pull on the release tab, and slide the connector from the port.

---



## Chapter 10

# Troubleshooting

---

This chapter contains suggestions on how to troubleshoot problems with the switch.

---

**Note**

For further assistance, please contact Allied Telesis Technical Support at <https://www.alliedtelesis.com/services/support-services>.

---

**Problem 1:** All the port LEDs and Switch ID LED are off, and the fans are not operating.

**Solutions:** The unit is not receiving power. Try the following:

- ❑ Verify that the power cord is securely connected to the power source and the AC connector on the back panel of the switch.
- ❑ Verify that the power outlet has power by connecting another device to it.
- ❑ Try connecting the unit to another power source.
- ❑ Try a different power cord.
- ❑ Verify that the voltage from the power source is within the required levels for your region. The power requirements for the switch are listed in “Power Specifications” on page 195.

**Problem 2:** All of the port LEDs are off even though the ports are connected to active network devices.

**Solution:** The switch might be operating in the low power mode. To toggle on the LEDs, press the eco-friendly button on the front panel of the switch. You can also toggle the LEDs off and on with the ECOFRIENDLY LED and NO ECOFRIENDLY LED commands in the command line interface.

**Problem 3:** A copper port on the switch is connected to an active network device but the port's LINK/ACT LED is off.

**Solutions:** The port is unable to establish a link to a network device. Try the following:

- ❑ Verify that the network device connected to the copper port is powered on and is operating properly.
- ❑ Try connecting another network device to the copper port with a different cable. If the copper port is able to establish a link, then the problem is with the cable or the other network device.
- ❑ Verify that the copper cable does not exceed 100 meters (328 feet).
- ❑ Verify that you are using the appropriate category of copper cable. Refer to "Cable Requirements" on page 34.
- ❑ Verify that the port is connected to the correct copper cable.

---

**Note**

Copper ports may require five to ten seconds to establish a link.

---

**Problem 4:** The LINK/ACT LED for an SFP or SFP+ transceiver is off.

**Solutions:** The fiber optic port on the transceiver is unable to establish a link to a network device. Try the following:

- ❑ Verify that the remote network device connected to the fiber optic port is operating properly.
- ❑ Verify that the fiber optic cable is securely connected to the port on the transceiver and to the port on the remote network device.
- ❑ Check that the transceiver is fully inserted in the port.
- ❑ Verify that the operating specifications of the fiber optic ports on the transceiver and remote network device are compatible.
- ❑ Verify that the correct type of fiber optic cabling is being used.
- ❑ Verify that the port is connected to the correct fiber optic cable.
- ❑ Try connecting another network device to the fiber optic port using a different cable. If the port is able to establish a link, then the problem is with the cable or with the other network device.
- ❑ Use the switch management software to verify that the port is enabled.
- ❑ If the remote network device is a managed device, use the management firmware to determine whether the port is enabled.
- ❑ Test the attenuation of both directions on the fiber optic cable with a fiber optic tester to determine whether the optical signal is too weak (sensitivity) or too strong (maximum input power).

- ❑ If the problem is with two BiDi (bi-directional) transceivers, refer to their data sheets to verify that their transmission and reception frequencies are opposite each other. For instance, a BiDi transceiver that transmits and receives at 1310nm and 1550nm, respectively, has to be connected to a transceiver that transmits and receives at 1550nm and 1310nm, respectively. Two BiDi transceivers will not establish a link if they transmit and receive at the same frequencies.

**Problem 5:** The SHOW STACK command is not displaying all the switches in the stack.

**Solutions:** If you are using 10Gbps ports for the stack trunk, try the following:

- ❑ Verify that the stacking ports are properly cabled. Refer to Chapter 9, “Cabling the Networking Ports” on page 173.
- ❑ If you are using SFP+ transceivers for the stack trunk, verify that they are fully inserted into the transceiver ports.
- ❑ If you are using SPI0TW direct connect twinax cables, verify that they are from Allied Telesis. The trunk will not work with cables from other network equipment manufacturers.
- ❑ Verify that the VCStack is activated on the switches. For instructions refer to “Verifying the Stack” on page 171.
- ❑ Verify the switches have the same software version, AlliedWare Plus v5.5.1-1.2.

**Problem 6:** Network performance between a copper port on the switch and a network device is slow.

**Solution:** There might be a duplex mode mismatch between the port and the network device. This can occur when a copper port using Auto-Negotiation is connected to a remote device that has a fixed speed of 10 or 100Mbps and a fixed duplex mode of full duplex. If this is the cause of the problem, adjust the duplex mode of the port on the network device or switch so that both ports are using the same duplex mode. You can use either the LEDs or management software on the switch to determine the duplex mode settings of the ports. The LEDs are described in “LEDs” on page 40.

**Problem 7:** The switch functions intermittently.

**Solutions:** Check the system hardware status through the management software:

- ❑ Use the SHOW SYSTEM ENVIRONMENT command in the Privileged Exec mode to verify that the input voltage from the power source to the switch is stable and within the approved operating range. The unit will shut down if the input voltage

fluctuates above or below the approved operating range.

- ❑ Use the SHOW SYSTEM ENVIRONMENT command in the Privileged Exec mode to verify that the fan is operating correctly.
- ❑ Verify that the location of the switch allows for adequate airflow. The unit will shut down if it is in danger of overheating.

**Problem 8:** The Switch ID LED on the front of the switch is flashing the letter “F.”

**Solutions:** One or more of the following problems has occurred:

- ❑ A cooling fan has failed.
- ❑ The internal temperature of the switch has exceeded the normal operating range and the switch may shut down.

Contact your Allied Telesis sales representative for assistance.

**Problem 9:** An x530 PoE switch is not providing power to a powered device or suddenly stopped providing power to a powered device.

**Solutions:** Try the following:

- ❑ Check the port’s PoE LED. If the LED is flashing amber, the switch has reached its maximum power budget and cannot support any additional PoE devices. Enter the SHOW POWER-INLINE command to display PoE status on the switch. The x530-28GPXm and x530-52GPXm switches have a power budget of 740W (370W per power supply). The x530-10GHXm and x530-18GHXm switches have a power budget of 1000W (500W per power supply).
- ❑ For a PoE or PoE+ device, review the powered device documentation to confirm that the device supports Mode A of the IEEE 802.3at standard. Mode A is one of two modes that define the connector pins that deliver the power from the port in the switch to the powered device. In Mode A, the power is carried on pins 1, 2, 3, and 6 on the RJ-45 port, the same pins that carry the network traffic. The second mode, Mode B, defines pins 4, 5, 7, and 8 as the power carriers. The x530 PoE switches support Mode A, but not Mode B. Most powered devices are designed to accept power by either mode, but some legacy devices may only support one mode. This can be verified by reviewing the device’s documentation or data sheet. Legacy PoE or PoE+ devices that only support Mode B will not work with the switch.

- ❑ Use the `SHOW SYSTEM ENVIRONMENT` command to confirm that both power supplies are operating normally.
- ❑ For a PoE++ device (Class 5 or higher) connected to the x530-10GHXm or x530-18GHXm switch, review its documentation to confirm that it uses all eight stands (four wire pair-sets) of the network cable for power.
- ❑ Verify that you are using the appropriate category of twisted-pair cable. Refer to “Cable Requirements” on page 34.
- ❑ Use the `SHOW POWER-INLINE` command to determine whether PoE is enabled on the port. The default setting for PoE is enabled.
- ❑ Use the management software on the switch to determine whether the PoE power setting for the port has been reduced to a value below the power requirements of the device.
- ❑ Try connecting the device to a different port on the switch.
- ❑ A power supply was powered off.
- ❑ A power supply or the AC power source has failed.
- ❑ The switch is overheating.

**Problem 9:** The switch functions intermittently.

**Solutions:** Check the system hardware status through the management software:

- ❑ Use the `SHOW SYSTEM ENVIRONMENT` command in the Privileged Exec mode to verify that the input voltage from the power source to the switch is stable and within the approved operating range. The unit will shut down if the input voltage fluctuates above or below the approved operating range.
- ❑ Use the `SHOW SYSTEM ENVIRONMENT` command in the Privileged Exec mode to verify that the fan is operating correctly.
- ❑ Verify that the location of the switch allows for adequate airflow. The unit will shut down if it is overheating.





## Appendix A

# Technical Specifications

---

This appendix contains the following sections:

- "Physical Specifications" on page 190
- "Environmental Specifications" on page 194
- "Power Specifications" on page 195
- "RJ-45 Copper Port Pinouts" on page 197
- "RJ-45 Style Serial Console Port Pinouts" on page 198
- "USB Port" on page 199

# Physical Specifications

## Dimensions

Table 28 lists the dimensions of the switches. The dimensions are shown in Figure 72 through Figure 78 on page 192.

Table 28. Product Dimensions

Model	Dimension (W x D x H)
x530-10GHXm	44.05 cm x 42.06 cm x 4.37 cm (17.35 in. x 16.56 in. x 1.72 in.)
x530-18GHXm	44.05 cm x 42.06 cm x 4.37 cm (17.35 in. x 16.56 in. x 1.72 in.)
x530-28GTXm	44.05 cm x 32.26 cm x 4.37 cm (17.344 in. x 12.7 in. x 1.72 in.)
x530-28GPXm	44.05 cm x 42.06cm x 4.37 cm (17.344 in. x 16.56 in. x 1.72 in.)
x530-28GSX	44.05 cm x 32.26 cm x 4.37 cm (17.344 in. x 12.7 in. x 1.72 in.)
x530-52GTXm	44.05 cm x 32.26 cm x 4.37 cm (17.344 in. x 12.7 in. x 1.72 in.)
x530-52GPXm	44.05 cm x 42.06 cm x 4.37 cm (17.344 in. x 16.56 in. x 1.72 in.)

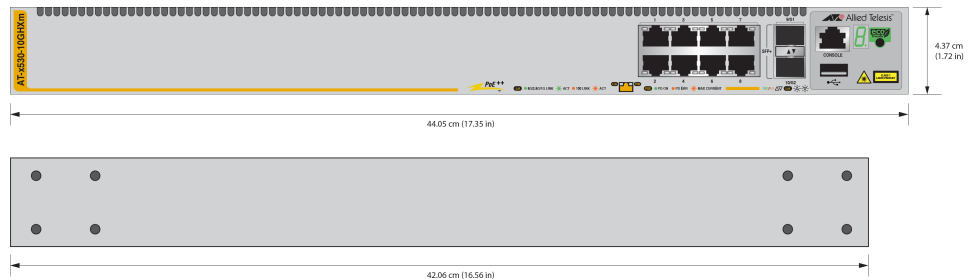

Figure 72. x530-10GHXm Dimensions

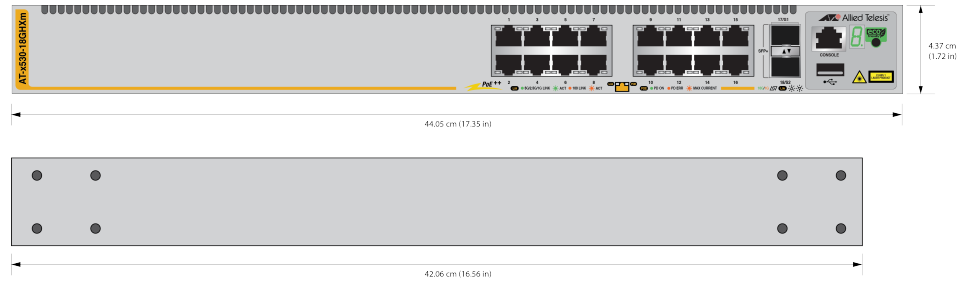

Figure 73. x530-18GHXm Dimensions

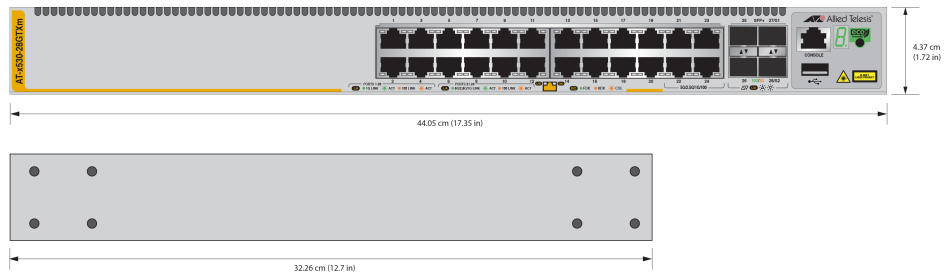

Figure 74. x530-28GTXm Dimensions

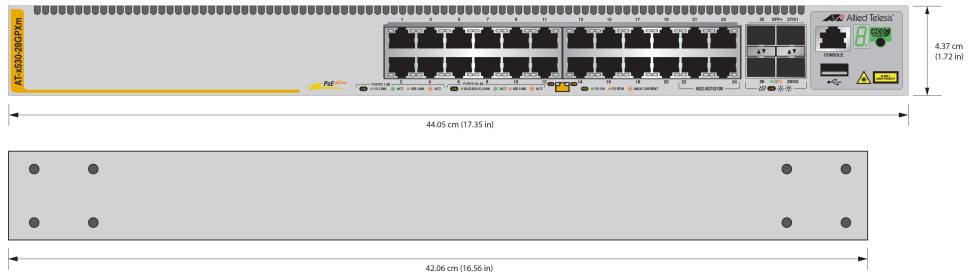

Figure 75. x530-28GPXm Dimensions

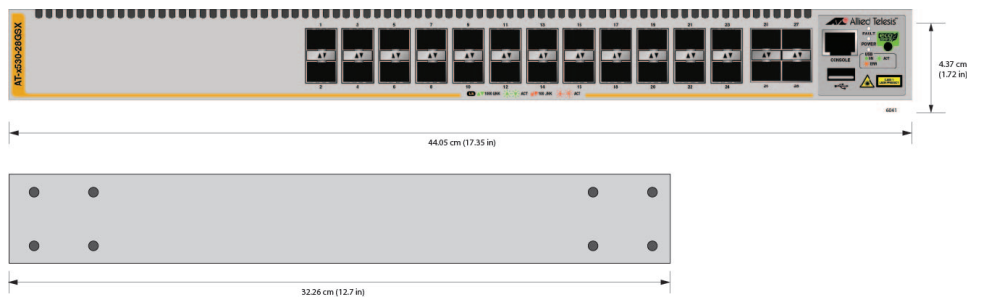

Figure 76. x530-28GSX Dimensions

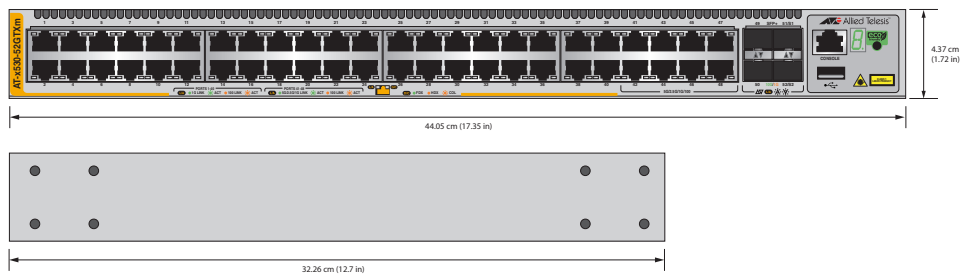

Figure 77. x530-52GTXm Dimensions

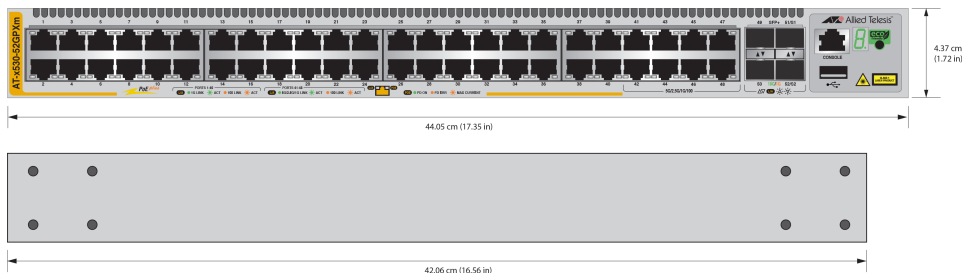

Figure 78. x530-52GPXm Dimensions

### Weights

Table 29 lists the weights of the switches.

Table 29. Product Weights

x530-10GHXm	6.6 kg (14.55 lb)
x530-18GHXm	6.7 kg (14.77 lb)
x530-28GTXm	4.42 kg (9.75 lb)
x530-28GPXm	6.31 kg (13.90 lb)
x530-28GSX	4.7 kg (10.36 lb)
x530-52GTXm	4.67 kg (10.5 lb)
x530-52GPXm	6.09 kg (13.7 lb)

## Ventilation

Table 30 lists the ventilation requirements.

Table 30. Ventilation Requirements

Recommended Minimum Ventilation on All Sides	10 cm (4.0 in)
--	----------------

## Environmental Specifications

---

Table 31 lists the environmental specifications of the switches.

Table 31. Environmental Specifications

Operating Temperature <sup>1</sup>	0° C to 50° C (32° F to 122° F)
Storage Temperature	-25° C to 70° C (-13° F to 158° F)
Operating Humidity	5% to 90% noncondensing
Storage Humidity	5% to 95% noncondensing
Maximum Operating Altitude	3,000 m (9,842 ft)
Maximum Nonoperating Altitude	4,000 m (13,100 ft)
Product Noise Level	More than 42 dB @ 30C or less
Installation Requirement	Tabletop, wall or rack mount

1. x530-28GSX only - If SFP+/SFP ports 25-28 are used with any of the 1/10Gbps modules listed below, then the maximum ambient operating temperature is limited to 45° C. Note that if the modules listed below are used on ports 1-24 and not on ports 25-28, then the maximum ambient operating temperature will remain unchanged at 50° C.

AT-SP10BD20-12  
 AT-SP10BD20-13  
 AT-SP10LR  
 AT-SP10LRM  
 AT-SP10SR  
 AT-SPBD10-13  
 AT-SPBD10-14  
 AT-SPBD80-A  
 AT-SPBD80-B  
 AT-SPBDM-A  
 AT-SPBDM-B  
 AT-SPEX  
 AT-SPLX10  
 AT-SPLX10a  
 AT-SPLX40  
 AT-SPSX  
 AT-SPTX  
 AT-SPTXa  
 AT-SPTXc  
 AT-SPZX80

## Power Specifications

---

This section contains the maximum power consumption values, input voltages, and heat dissipation values.

### Maximum Power Consumption

Table 32 lists the maximum power consumptions for the switches.

Table 32. Maximum Power Consumptions

x530-10GHXm	970 watts
x530-18GHXm	1400 watts
x530-28GTXm	55 watts
x530-28GPXm	900 watts
x530-28GSX	62 watts
x530-52GTXm	88 watts
x530-52GPXm	970 watts

### Input Voltages

Table 33 lists the input voltages for the switches.

Table 33. Input Voltages<sup>1</sup>

x530-10GHXm	100-240 VAC~, 7.6A per input (x2) maximum, 50/60 Hz
x530-18GHXm	100-240 VAC~, 7.6A per input (x2) maximum, 50/60 Hz
x530-28GTXm	100-240 VAC~, 1.0A per input (x2) maximum, 50/60 Hz
x530-28GPXm	100-240 VAC~, 6.0A per input (x2) maximum, 50/60 Hz
x530-28GSX	100-240 VAC~, 1.0A per input (x2) maximum, 50/60 Hz
x530-52GTXm	100-240 VAC~, 1.5A per input (x2) maximum, 50/60 Hz
x530-52GPXm	100-240 VAC~, 6.0A per input (x2) maximum, 50/60 Hz

1. This information can be found on the rating label. The rating label is put on the bottom of the product.

## Heat Dissipation

Table 34 lists the heat dissipation for the switches.

Table 34. Heat Dissipation

x530-10GHXm	3300 BTU/hr
x530-18GHXm	4700 BTU/hr
x530-28GTXm	190 BTU/hr
x530-28GPXm	614 BTU/hr
x530-28GSX	212 BTU/hr
x530-52GTXm	300 BTU/hr
x530-52GPXm	661 BTU/hr



## RJ-45 Copper Port Pinouts

Figure 79 illustrates the pin layout of the RJ-45 connectors on the front panel of the switch.

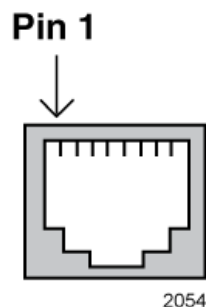

Figure 79. RJ-45 Socket Pin Layout (Front View)

Table 35 lists the pin signals.

Table 35. Pin Signals for 100M/1G/2.5G/5G Base-T Connectors

Pin	100Mbps MDI Signal	100Mbps MDI-X Signal	1G/2.5G/5G Signal
1	TX+	RX+	Bi-directional pair A+
2	TX-	RX-	Bi-directional pair A-
3	RX+	TX+	Bi-directional pair B+
4	Not used	Not used	Bi-directional pair C+
5	Not used	Not used	Bi-directional pair C-
6	RX-	TX-	Bi-directional pair B-
7	Not used	Not used	Bi-directional pair D+
8	Not used	Not used	Bi-directional pair D-

## RJ-45 Style Serial Console Port Pinouts

---

Table 36 lists the pin signals of the RJ-45 style serial console port.

Table 36. RJ-45 Style Serial Console Port Pin Signals

<b>Pin</b>	<b>Signal</b>
1	RTS#
2	Not used
3	Transmit Data
4	Ground
5	Ground
6	Receive Data
7	Not used
8	CTS

## USB Port

---

Table 37 lists the pin signals of the USB port.

Table 37. USB Port Pin Signals

<b>Pin</b>	<b>Signal</b>
1	+5V
2	DATA-
3	DATA+
X	NC
4	GND

